

Dated the _____ day of _____

MTR CORPORATION LIMITED
(香港鐵路有限公司)
as the registered owner

and

[_____]
as the Purchaser

and

[_____]
as the Manager

SUB-DEED OF MUTUAL COVENANT
and
MANAGEMENT AGREEMENT
in respect of
SITE B of ABERDEEN INLAND LOT NO.467

(Draft 11: 30 June 2021)

Deacons

5th Floor
Alexandra House
18 Chater Road
Central, Hong Kong
hongkong@deacons.com
www.deacons.com
Tel: +852 2825 9211
Fax: +852 2825 0431

LC:WW:WOANTH 2019/392882

SUB-DEED OF MUTUAL COVENANT AND MANAGEMENT AGREEMENT

INDEX

SECTION A : PARTIES AND RECITALS

Date

Parties

Recitals

1. Supplemental
2. Development
3. Allocation of Shares
4. Assignment
5. Purpose of Deed
6. Approval

OPERATIVE PARTS

SECTION B : DEFINITIONS

SECTION C : RIGHTS OF OWNERS

1. Rights attaching to each Share
2. Rights of MTR
3. Rights of Purchaser
4. Disposal Restrictions

SECTION D : OBLIGATIONS OF OWNERS AND POWERS OF MANAGER

1. Owners to comply, liability of Manager and Owners to indemnify the Manager
2. Owners to observe restrictive covenants
3. Management Charges
4. Assignment of Common Areas and Common Services and Facilities
5. Phase 2 Residential Units with open kitchen
6. Curtain walls and casement windows
7. Ownership and maintenance of Non-Common EV Facilities
8. Compliance with Ordinances, etc. in respect of Non-Common EV Facilities
9. Compliance with Ordinances, etc. in respect of EV Facilities for Visitors' Car Parking Spaces in Phase 2
10. Phase 2 Noise Mitigation Measures
11. Electricity supply
12. Maintenance of private hose reels

SECTION E : MEETINGS OF THE OWNERS OF PHASE 2

1. Meetings of the Owners
2. Annual Meeting
3. Convening of Meeting
4. Notice
5. Quorum
6. Chairman
7. Minutes
8. Voting
9. Resolutions binding on Owners
10. Accidental omission of notice
11. Resolutions requiring special majority
12. Audit of annual accounts

SECTION F : PHASE 2 OWNERS' SUB-COMMITTEE

1. Number of members
2. Quorum
3. Eligibility for appointment
4. Election of members
5. Officers
6. Tenure of office
7. Votes of members
8. Power to make rules
9. Manager to be invited
10. Power to call meeting

SECTION G : PHASE 2 HOUSE RULES

1. Phase 2 House Rules first in force
2. Making and amendment of Phase 2 House Rules
3. Phase 2 House Rules to be posted on notice boards
4. Phase 2 House Rules not adversely affect Government Accommodation

SECTION H : INTERPRETATION AND MISCELLANEOUS

1. Marginal notes, headings and index
2. Plurals and genders
3. Service of notices
4. Covenants to run with the Land
5. Chinese Translation
6. The Ordinance

- (b) making specific provisions for the management of Phase 2;
- (c) appointing [] as the Manager to exercise the powers and perform the duties on its part for the periods and on the terms and conditions herein contained; and
- (d) identifying those parts of Phase 2 which will form part of the Common Areas and the Common Services and Facilities under the Principal Deed.

Approval

6. The Director has given his approval to this Deed in accordance with the Government Grant.

OPERATIVE PARTS

NOW THIS DEED WITNESSETH that the parties hereto have agreed and DO HEREBY COVENANT with each other as follows to the intent that this Deed shall enure to the benefit of and shall bind each of them and their respective successors in title and persons deriving title under or through them or any of them and all persons who may hereafter during the Term become an Owner.

SECTION B

DEFINITIONS

1. Terms (other than those set out in Clause 2 hereof) defined in the Principal Deed shall have the same meaning when used in this Deed.
2. In this Deed the following words and expressions shall have the meanings ascribed to them except where the context otherwise requires :

“Approved Plans” means the building plans for Phase 2 of the Estate approved by the Building Authority and/or the Director as from time to time amended, modified or substituted;

“Authorized Person” means Ms. Lee Ming Yen Jennifer of P&T Architects & Engineers Limited, 33rd Floor, 633 King’s Road, North Point, Hong Kong, and any other replacement authorized person for the time being appointed by MTR for Phase 2 of the Estate;

“Deed” means this Deed as amended or varied or supplemented from time to time;

“Estate Common Areas in Phase 2” means those parts of the Estate Common Areas situated within Phase 2 which are intended for use by Owners of the Estate and not for the sole benefit of any Owner, group of Owners or Owners of a particular Phase including, but not limited to the Future Footbridge Associated Structures (as defined in Special Condition No.(12)(b) of the Government Grant), the Pedestrian Walkway in Phase 2 (including those parts provided or to be provided adjacent to Site B but outside the Land solely for management and maintenance purposes), part of the Phase 2 Greenery Areas, planters, fireman’s lift lobbies, accessible lift, hose reels, electrical duct, fire shutter, corridors, staircases and landings, parapet walls, structural walls and columns, the foundations and other structural elements of the buildings erected on the Estate serving more than one Phase and within Site B (but excluding those forming part of the Station or the Depot), but excluding the Residential Development Common Areas in Phase 2, the Phase 2 Common Areas, the Phase 2 Residential Common Areas and the Phase 2 Car Park Common Areas; and the Estate Common Areas in Phase 2 are for the purpose of identification shown coloured Indigo, Indigo Cross-hatched Black and Indigo Cross-hatched

Black Stippled Black on the plans certified as to their accuracy by the Authorized Person and annexed hereto;

“Estate Common Services and Facilities in Phase 2”

means those services and facilities forming parts of the Estate Common Services and Facilities in, on or under Phase 2 and which serve the Estate and not for the sole benefit of any Owner, group of Owners or Owners of a particular Phase including, but not limited to, sewers, gutters, drains, pipes and ducts; pumps, tanks; lighting, wires, cables, electrical installations, fittings, equipment and apparatus; fire protection and fighting services; security systems, equipment and apparatus; lift and escalators; ventilation and fans and any other installations, systems, plant, equipment, apparatus, fittings, services and facilities and other ancillary facilities installed in or serving the Estate Common Areas in Phase 2 but excluding the Residential Development Common Services and Facilities in Phase 2, the Phase 2 Common Services and Facilities, the Phase 2 Residential Common Services and Facilities and the Phase 2 Car Park Common Services and Facilities;

“EV Facilities for Visitors’ Car Parking Spaces in Phase 2”

means all such EV Facilities for Visitors’ Car Parking Spaces installed or to be installed within the Phase 2 Car Park for the purpose of or in relation to the charging of electric motor vehicles licensed under the Road Traffic Ordinance (Cap. 374 of the Laws of Hong Kong), any regulations made thereunder and any amending legislation, and parking at the Visitors’ Car Parking Spaces in Phase 2 and such facilities shall include but not limited to such wires, cables, ducts, trunking, electric meters, base boxes, socket outlets, locks, covers and other security and/or protective devices, charging station, payment device, equipment, apparatus and such other electrical or other installations or otherwise for or in relation to such purpose;

“Fire Safety Management Plan”

means the fire safety management plan and measures relating to the Phase 2 Residential Units with open kitchen design required to be implemented by the Buildings Department and the Fire Services Department and any addition or variation thereto from time to time in accordance with the then relevant requirements of the Buildings Department, the Fire Services Department and any other relevant Government authority;

“First Assigned Premises”

means [];

“Management Units”

means the Management Units attributable to the Phase 2 Car Parking Spaces and the Phase 2 Residential Units as set out in Part II of the First Schedule;

“Non-Common EV Facilities”

means such facilities installed or to be installed within the Phase 2 Car Park forming part of and exclusively serving a Phase 2 Car Parking Space for the purpose of or in relation to the charging of electric motor vehicles or electric motor cycles licensed under the Road Traffic Ordinance (Cap.

374 of the Laws of Hong Kong), any regulations made thereunder and any amending legislation, and parking at such Phase 2 Car Parking Space; such facilities shall include but not limited to such wires, cables, ducts, trunking, electric meters, base boxes, socket outlets, locks, covers and such other security and/or protective devices, equipment, apparatus and such other electrical or other installations or otherwise for or in relation to such purpose;

**“Pedestrian Walkway
in Phase 2”**

means those parts of the covered pedestrian walkway provided or to be provided in Site B and those parts of the covered pedestrian walkway provided or to be provided adjacent to Site B but outside the Land (which are included herein solely for management and maintenance purposes) pursuant to Special Condition No.(59)(c) of the Government Grant, which are for the purpose of identification as shown coloured Indigo Cross-hatched Black and Indigo Cross-hatched Black Stippled Black on the plans certified as to their accuracy by the Authorized Person and annexed hereto;

“Phase 2”

means that part of the Estate constructed on Site B of the Land comprising the Towers, the Phase 2 Car Parking Spaces, recreational facilities and common areas and facilities now known as **“La Marina (揚海)”**;

“Phase 2 Balcony”

means each of the Balconies forming part of a Phase 2 Residential Unit specified in the Sixth Schedule, and for the avoidance of doubt, the Phase 2 Balconies include acoustic balconies and noise absorptive wall lining of the Phase 2 Noise Mitigation Measures installed thereat and the Phase 2 Balconies are for the purpose of identification shown and marked **“BAL.”** on the plans certified as to their accuracy by the Authorized Person and annexed hereto;

“Phase 2 Car Park”

means that part of the Car Park within Phase 2 indicated on the Approved Plans for the parking of motor vehicles or motor cycles licensed under the Road Traffic Ordinance (Cap. 374 of the Laws of Hong Kong), any regulations made thereunder and any amending legislation, and belonging to the residents of the Residential Development, or their bona fide guests, visitors or invitees, and includes areas intended for the common use and benefit of the Owners, occupiers and licensees of such part of the Car Park within Phase 2, and for the avoidance of doubt, also includes the Visitors’ Car Parking Spaces in Phase 2;

**“Phase 2 Car Park
Common Areas”**

means the whole of the Phase 2 Car Park (except those Phase 2 Car Parking Spaces and the Visitors’ Car Parking Spaces in Phase 2) intended for the common use and benefit of the Owners, occupiers and licensees of the Phase 2 Car Parking Spaces and the occupiers and licensees of the Visitors’ Car Parking Spaces in Phase 2 including, but not limited to, driveways, ramps, corridors, staircases and landings, electrical room, reinforced concrete parapet, protected lobbies, pipe ducts and hose reels but excluding the Estate Common Areas in Phase 2, the Residential

Development Common Areas in Phase 2, the Phase 2 Common Areas and the Phase 2 Residential Common Areas; and the Phase 2 Car Park Common Areas are for the purpose of identification shown coloured Green on the plans certified as to their accuracy by the Authorized Person and annexed hereto;

**“Phase 2 Car Park
Common Services and
Facilities”**

means those services and facilities in on or under Phase 2 and which serve the Phase 2 Car Park as a whole including, but not limited to, plant and machinery, barriers and water supply apparatus; sewers, gutters, drains, pipes and ducts; pumps, tanks; lighting, wires, cables, electrical installations, fittings, equipment; fire protection and fire fighting services; ventilation and fans but excluding the Estate Common Services and Facilities in Phase 2, the Residential Development Common Services and Facilities in Phase 2, the Phase 2 Common Services and Facilities and the Phase 2 Residential Common Services and Facilities;

**“Phase 2 Car Parking
Space”**

means a Unit situate in the Phase 2 Car Park provided pursuant to Special Condition Nos.(68)(a)(i) and (68)(d)(i)(I) of the Government Grant for the purpose of parking of motor vehicle or motor cycle licensed under the Road Traffic Ordinance (Cap. 374 of the Laws of Hong Kong), any regulations made thereunder and any amending legislation, and belonging to a resident of the Residential Development or his bona fide guest, visitor or invitee, and for the avoidance of doubt, includes the Non-Common EV Facilities (if any) exclusively serving such Unit;

**“Phase 2 Common
Areas”**

means those parts of Phase 2 which are intended for use by the Owners of more than one constituent parts of Phase 2, namely the Phase 2 Car Park and the Phase 2 Residential Development and not for the sole benefit of the Owners of only one constituent part including, but not limited to, fixed fire pump room, fire services water tank, lift shafts, lifts, accessible lifts, fireman’s lift lobbies, pipe ducts, hose reels, corridors, protected lobbies, staircases and landings, electrical rooms, air-conditioning plant rooms, main telecommunications and broadcasting equipment room, master water meter room, fire services inlets, sprinkler inlets, electrical ducts, fuel tank room, sump pump room, high voltage switch rooms, cable riser rooms, drencher inlets, planter, rainwater sump pit, sprinkler water tank, sprinkler water pump room, water meter cabinets, sump pit, fire shutters, driveway, emergency generator room, exhaust fan room, cable riser duct room, low voltage switch room, waste water pump room, irrigation plant room, flushing and potable water pump room, fire services control room, drencher deluge valve room, transformer room, caretaker’s office, exhaust air duct, fresh air duct and all other common parts specified in Schedule 1 to the Ordinance (if any) within Phase 2 not used for the sole benefit of the Owners of any one constituent part of Phase 2 only but excluding the Estate Common Areas in Phase 2, the Residential Development Common Areas in Phase 2, the Phase 2 Residential Common Areas and the Phase 2 Car Park Common Areas; and the Phase 2 Common Areas are for the purpose of identification

shown coloured Orange on the plans certified as to their accuracy by the Authorized Person and annexed hereto;

“Phase 2 Common Services and Facilities”

means those services and facilities constructed or to be constructed in on or under Phase 2 and which serve more than one constituent parts of Phase 2, namely the Phase 2 Car Park and the Phase 2 Residential Development including, but not limited to, sewers, gutters, drains, pipes and ducts; pumps, tanks and sanitary fittings; lighting (including but not limited to the high ceiling lighting and light poles within Phase 2 for the adjacent public road), wires, cables, electrical installations, fittings, equipment and apparatus; communal aerial distribution and associated equipment; fire protection and fire fighting systems, equipment and apparatus; security systems, equipment and apparatus; refuse disposal equipment; lifts, air-conditioners and fans; architectural features and any other installations, systems, plant, equipment, apparatus, fittings, services and facilities used or installed in or for the benefit of Phase 2 as part of the amenities thereof and not for the sole benefit of any one constituent part of Phase 2 only but excluding the Estate Common Services and Facilities in Phase 2, the Residential Development Common Services and Facilities in Phase 2, the Phase 2 Residential Common Services and Facilities and the Phase 2 Car Park Common Services and Facilities;

“Phase 2 Greenery Areas”

means the greenery areas (including the vertical greenery areas) provided or to be provided pursuant to Special Condition No.(26)(b)(iii) of the Government Grant in Phase 2, and for identification purpose only shown coloured Indigo Cross-hatched Black Stippled Black, Red Stippled Black and Yellow Stippled Black on the plans certified as to their accuracy by the Authorized Person and annexed hereto;

“Phase 2 House Rules”

means the House Rules set out in the Fourth Schedule hereto as varied or modified by the Manager from time to time in accordance with Clause 2 of Section G;

“Phase 2 Noise Mitigation Measures”

means such noise canopy (noise barrier), acoustic windows, acoustic balconies, self-closing doors and noise absorptive wall lining provided within Phase 2 as approved by the Director of Environmental Protection, and any subsequent amendments thereto (if any) approved by the Director of Environmental Protection;

“Phase 2 Owners’ Sub-Committee”

means the Owners’ Sub-Committee elected in accordance with the provisions of Section F of this Deed;

“Phase 2 Recreational Areas and Facilities”

means the reception, entrance lobby, swimming pools (including the filtration plant room and surge tank on 3rd Floor serving the swimming pools), pool decks, gymnasium, suspension training/yoga/dance/boxing room (breath studio), female changing rooms, male changing rooms, lavatories, lobby, function rooms, clubhouse office, game room, game area, children play room, children play area, multi-media room, sitting

area within Phase 2 and any other recreational facilities erected within Phase 2 pursuant to the provisions of Special Condition No.(55)(a) of the Government Grant which are now or may at any time during the Term be provided only for the benefit of the residents of the Phase 2 Residential Development and their bona fide visitors, all of which shall form part of the Private Recreational Facilities;

**“Phase 2 Residential
Common Areas”**

means those parts of the Phase 2 Residential Development intended for the common use and benefit of the Owners, occupiers and licensees of the Phase 2 Residential Development including, but not limited to, the external walls of the Podium Floor and above of the buildings erected on Phase 2 (including curtain walls or any part thereof (including the window frames, glass panels, hinges, locks, handles, cast-in anchors, gasket, window sealant and such other components of the curtain walls, the non-openable windows therein or thereto and window frames, glass panels, cast-in anchors, gasket, window sealant and such other components of such non-openable windows but excluding all openable windows installed therein and the frames enclosing the glass panels of the openable windows, glass panels, hinges, locks, handles, cast-in anchors, gasket, window sealant and such other components of such openable windows) and non-structural prefabricated external walls which are for the purpose of identification shown by Red Dotted Lines on the plans certified as to their accuracy by the Authorized Person and annexed hereto, and any architectural features, grilles, louvers, external finishes and claddings (including those external finishes and claddings of the Phase 2 Balconies and the Phase 2 Utility Platforms and the cladding panels enclosing the exterior pipe ducts)), noise canopy (noise barrier) of the Phase 2 Noise Mitigation Measures, part of the Phase 2 Greenery Areas, the Phase 2 Wider Common Corridors and Lift Lobbies, the loading/unloading space for refuse collection vehicle, loading and unloading bays, the Phase 2 Recreational Areas and Facilities, parts and/or areas within Phase 2 designated for and in connection with the operation of gondola (including gondola landing areas located within gardens or flat roofs of the Phase 2 Residential Units and the flooring and enclosing walls of such gondola landing areas), the gas valve room, fire services transfer pump room, water meter cabinets, fire services transfer water tank, refuse storage and material recovery chamber, sprinkler water pump room, sprinkler water tank, lift lobbies, fireman’s lift lobbies, lifts, accessible lifts, lift pits and lift overrun, protected lobbies, corridors, staircases and landings, low voltage switch rooms, filtration plant rooms, surge tank, gas duct, drencher water pump rooms, drencher water tanks, sprinkler water tanks, fire services transfer water tanks, fire services transfer and sprinkler water pump room, electrical rooms, flushing and potable water pump rooms, protected corridors, open landscaped areas, hard paved landscaped area, covered landscaped area, landscaped area, planters, driveways, ramps, covered walkway (horizontal screen), sprinkler control valve rooms, fire services inlet, sprinkler inlet, drencher inlet and drencher deluge valve room, temporary refuge spaces, common

green area, air-conditioning plinths, pipe wells, fixed fire pump rooms, fire services water tanks, flat roof, air-conditioner platforms, hose reels, extra low voltage ducts, pipe ducts, electrical meter cabinets, refuse storage and material recovery rooms, refuge areas, flushing water pump rooms, lift machine rooms, raised platforms, flushing water tank room, flushing water tanks, potable water pump rooms, potable water tanks, top roofs, covers and roofs of the Phase 2 Balconies, covers and roofs of the Phase 2 Utility Platforms, architectural features, all structural columns (if any) within or appertaining to any Phase 2 Residential Unit and all other common parts specified in Schedule 1 to the Ordinance (if any) within the Phase 2 Residential Development for the common use and benefit of the Owners, occupiers and licensees of the Phase 2 Residential Development but excluding the Estate Common Areas in Phase 2, the Residential Development Common Areas in Phase 2, the Phase 2 Common Areas and the Phase 2 Car Park Common Areas; and the Phase 2 Residential Common Areas are for the purpose of identification shown coloured Yellow, Yellow Stippled Black and Yellow Cross-hatched Black and by Red Dotted Lines on the plans certified as to their accuracy by the Authorized Person and annexed hereto;

**“Phase 2 Residential
Common Services
and Facilities”**

means those services and facilities in on or under Phase 2 of the Estate and which serve more than one Phase 2 Residential Unit including but not limited to, gondola and lifting platforms, sewers, gutters, drains, water features, pipes and ducts; pumps, tanks and sanitary fittings; water supply apparatus; lighting, wires, cables, electrical installations, fittings, equipment and apparatus; communal aerial, distribution and associated equipment; fire protection and fire fighting systems, equipment and apparatus; security systems, equipment and apparatus, refuse disposal equipment, lifts, air-conditioners and fans, architectural features but excluding the Estate Common Services and Facilities in Phase 2, the Residential Development Common Services and Facilities in Phase 2, the Phase 2 Common Services and Facilities and the Phase 2 Car Park Common Services and Facilities;

**“Phase 2 Residential
Development”**

means that part of the Residential Development comprising the Towers as indicated on the Approved Plans for residential use;

**“Phase 2 Residential
Unit”**

means a Unit including any of the Phase 2 Noise Mitigation Measures within or serving the Unit exclusively, Phase 2 Balcony, Phase 2 Utility Platform, flat roof(s), roof (including any hose reel(s) and associated manual fire alarm system thereat), garden(s), stairhood and/or air-conditioning plinth(s) appertaining thereto and held with and forming part of such Unit situate in the Phase 2 Residential Development; for the avoidance of doubt it is expressly provided and declared that a Phase 2 Residential Unit shall include (i) all openable windows (including any maintenance windows) installed in or to any curtain wall enclosing the Phase 2 Residential Unit and the frames enclosing the glass panels of the openable windows, glass panels, hinges, locks, handles, cast-in anchors,

gasket, window sealant and such other components of such openable windows, (ii) casement windows (whether openable or not) installed in or to any external walls (other than curtain walls) enclosing the Phase 2 Residential Unit and the window frame on such external walls, frames enclosing the glass panels of the casement windows, glass panels, hinges, locks, handles, cast-in anchors, gasket, window sealant and such other components of such casement windows, (iii) the plaster and covering of the internal surface of the external walls enclosing the Phase 2 Residential Unit and the plaster and covering of the internal surface of other enclosing walls abutting on the Phase 2 Residential Common Areas enclosing such Phase 2 Residential Unit (but not any other part of those walls), (iv) all non-structural or non-load bearing internal partitions and walls and any aluminium wall cladding (without sound absorbing material) and aluminium ceiling cladding (without sound absorbing material) of such Phase 2 Residential Unit (but in case of a non-structural Party Wall adjoining two Phase 2 Residential Units only up to the mid point of such Party Wall) and (v) any fire rated resistant wall, smoke detector and fire alarm of the automatic fire detection system, sprinkler pipes and sprinkler heads of the sprinkler system serving such Phase 2 Residential Unit with open kitchen exclusively but shall exclude all structural columns (if any) within or appertaining to the Phase 2 Residential Unit;

“Phase 2 Utility Platform”

means each of the Utility Platforms forming part of a Phase 2 Residential Unit specified in the Sixth Schedule and for identification purpose only as shown and marked “U.P.” on the plans certified as to their accuracy by the Authorized Person and annexed hereto;

“Phase 2 Wider Common Corridors and Lift Lobbies”

means the wider common corridors and lift lobbies provided as green features in Phase 2 pursuant to the Joint Practice Note No.1 of the Buildings Department, the Lands Department and the Planning Department of the Government, and for identification purpose only shown coloured Yellow Cross-hatched Black on the plans certified as to their accuracy by the Authorized Person and annexed hereto;

“Phase 2 Works and Installations”

means all the Works and Installations in Phase 2 requiring regular maintenance on a recurrent basis including but not limited to those works and installations as set out in the Fifth Schedule hereto;

“Principal Deed”

means the Principal Deed of Mutual Covenant and Management Agreement dated [] and registered in the Land Registry by Memorial No.[] affecting the Land;

“Residential Development Common Areas in Phase 2”

means those parts of the Residential Development Common Areas situated within Phase 2 which are intended for the common use and benefit of the Owners of the Residential Development in more than one Phase and not for the sole benefit of any Owner or group of Owners of the Residential Development in a Phase including, but not limited to the Visitors’ Car Parking Spaces in Phase 2, part of the Phase 2 Greenery

Areas, driveways, planters, hard paved landscaped area, open landscaped areas, street fire hydrant water pump room, street fire hydrant water tank, parapet walls, structural walls and columns within or appertaining to the Residential Development in more than one Phase and within Site B but excluding the Estate Common Areas in Phase 2, the Phase 2 Common Areas, the Phase 2 Residential Common Areas and the Phase 2 Car Park Common Areas; and the Residential Development Common Areas in Phase 2 are for the purpose of identification shown coloured Red and Red Stippled Black on the plans certified as to their accuracy by the Authorized Person and annexed hereto;

“Residential Development Common Services and Facilities in Phase 2”

means those services and facilities forming parts of the Residential Development Common Services and Facilities in, on or under Phase 2 and which serve the Residential Development in more than one Phase and not for the sole benefit of any Owner or group of Owners of the Residential Development in a Phase including, but not limited to, the EV Facilities for Visitors’ Car Parking Spaces in Phase 2, sewers, gutters, drains, pipes and ducts; pumps, tanks; water supply apparatus; lighting, wires, cables, electrical installations, fittings, equipment and apparatus; fire protection and fighting services; fire-fighting systems, equipment and apparatus; security systems, equipment and apparatus; ventilation and fans and any other installations, systems, plant, equipment, apparatus, fittings, services and facilities and other ancillary facilities installed in or serving the Residential Development Common Areas in Phase 2 but excluding the Estate Common Services and Facilities in Phase 2, the Phase 2 Common Services and Facilities, the Phase 2 Residential Common Services and Facilities and the Phase 2 Car Park Common Services and Facilities;

“Site B”

means the portion or portions or strata or stratum of the Land as shown and marked “SITE B” on Plan Ic annexed to the Government Grant (as may be replaced by the detail boundary plan(s) referred to in Special Condition No.(7) of the Government Grant approved by the Director and registered in the Land Registry from time to time) and referred to in the Government Grant as “Site B”;

“Tower”

means a residential tower block constructed as part of the Phase 2 Residential Development; and

“Visitors’ Car Parking Spaces in Phase 2”

means the Visitors’ Car Parking Spaces in the Phase 2 Car Park provided pursuant to Special Condition No.(68)(a)(iii) of the Government Grant designated for parking of motor vehicles licensed under the Road Traffic Ordinance (Cap. 374 of the Laws of Hong Kong), any regulations made thereunder and any amending legalisation, and belonging to the bona fide guests, visitors or invitees of the residents of the Residential Development, being the parking spaces for disabled persons provided in Site B pursuant to Special Condition No.(68)(c)(i) of the Government Grant.

SECTION C

RIGHTS OF OWNERS

Rights attaching to each Share

1. Each Share allocated to Phase 2 of the Estate shall during the residue of the Term and any renewal thereof subject to the covenants and terms contained in the Government Grant, the Principal Deed and this Deed be held by the person or persons from time to time entitled thereto together with :

- (a) the full and exclusive right and privilege to hold, use and occupy the Unit designated opposite to it in the First Schedule hereto; and
- (b) the benefit, insofar as applicable, of the easements, rights and privileges set out in Part I of the Second Schedule hereto;

but subject to the exceptions and reservations set out in Part II of the Second Schedule hereto.

Rights of MTR

2. MTR shall during the residue of the Term and any renewal thereof subject to the covenants and terms contained in the Government Grant, the Principal Deed and this Deed have the full and exclusive right and privilege to hold, use, occupy and enjoy the whole of Phase 2 Together with the appurtenances thereto save and except the First Assigned Premises.

Rights of Purchaser

3. The Purchaser shall during the residue of the Term and any renewal thereof subject to the covenants and terms contained in the Government Grant, the Principal Deed and this Deed have the full and exclusive right and privilege to hold, use, occupy and enjoy the First Assigned Premises together with the appurtenances thereto.

Disposal Restrictions

4. (a) The right to the exclusive use, occupation and enjoyment of any Phase 2 Residential Unit or Phase 2 Car Parking Space or any part thereof shall not be sold, assigned, mortgaged, charged, leased (other than for a term of less than ten (10) years), licensed or otherwise disposed of separately from the Share with which the same is held.

(b) Phase 2 Car Parking Spaces shall not be used for any purpose other than for the purposes of parking of motor vehicles or motor cycles (as the case may be) licensed under the Road Traffic Ordinance (Cap. 374 of the Laws of Hong Kong), any regulations made thereunder and any amending legislation and belonging to the residents of the Residential Development or their bona fide guests, visitors or invitees in accordance with the Approved Plans and the Government Grant and in particular the Phase 2 Car Parking Spaces shall not be used for the storage,

display or exhibiting of motor vehicles for sale or otherwise or for the provision of car cleaning and beauty services.

SECTION D

OBLIGATIONS OF OWNERS AND POWERS OF MANAGER

Owners to comply

1. (a) The Owners of Units in Phase 2 (including MTR) and the Manager shall at all times hereafter so long as they remain as Owners of any Shares in Phase 2 or the Manager (as the case may be) comply with and shall observe and perform the covenants, provisions, restrictions and prohibitions contained in :

- (i) the Government Grant;
- (ii) the Principal Deed; and
- (iii) this Deed.

Liability of Manager

(b) The Manager, when exercising its right to enter on, into or upon any Unit in Phase 2 in accordance with Clause 2(a) of Part II of the Second Schedule to the Principal Deed, shall repair at its own costs and expense any damage so caused and shall be liable for the negligent, wilful or criminal acts of the Manager, its employees, agents and contractors.

Owners to indemnify the Manager

(c) Nothing contained in the Principal Deed and this Deed shall exclude the liability of the Manager to the Owners of Units in Phase 2 for any act or omission involving criminal liability, dishonesty or negligence on the part of the Manager or its employees, agents or contractors and no Owner of a Unit in Phase 2 shall be required to indemnify the Manager or its employees, agents or contractors from and against any actions, claims etc. arising out of any act or omission.

Owners to observe restrictive covenants

2. The Owners of a Unit in the Phase 2 Residential Development and the Phase 2 Car Park shall at all times hereafter be bound by and shall observe and perform the covenants, restrictions and prohibitions set out in the Third Schedule hereto insofar as the same are applicable to them.

Management Charges

3. Each Owner of a Unit in Phase 2 shall upon demand pay to the Manager the Management Charges in respect of any Unit owned by him, calculated in accordance with the provisions of Section J of the Principal Deed.

Assignment of Common Areas and Common Services and Facilities

4. MTR shall upon execution of this Deed assign the whole of the Shares in the Estate Common Areas in Phase 2 and the Estate Common Services and Facilities in Phase 2, the Residential Development Common Areas in Phase 2 and the Residential Development Common Services and Facilities in Phase 2, the Phase 2 Common Areas and the Phase 2 Common Services and Facilities, the Phase 2 Residential Common Areas and the Phase 2 Residential Common Services and Facilities and the Phase 2 Car Park Common Areas and the Phase 2 Car Park Common Services and Facilities together with the Estate Common Areas in Phase 2 and the Estate Common Services and Facilities in Phase 2, the Residential Development

Common Areas in Phase 2 and the Residential Development Common Services and Facilities in Phase 2, the Phase 2 Common Areas and the Phase 2 Common Services and Facilities, the Phase 2 Residential Common Areas and the Phase 2 Residential Common Services and Facilities and the Phase 2 Car Park Common Areas and the Phase 2 Car Park Common Services and Facilities to the Manager free of costs or consideration to be held by the Manager as trustee for all the Owners and the Manager must assign the said Shares together with the said areas and services and facilities free of costs or consideration to its successor as manager on termination of its appointment or to the Owners' Corporation at any time if so required by the Owners' Corporation.

**Phase 2 Residential
Units with open kitchen**

5. (a) Each Owner of Phase 2 Residential Units with open kitchen shall in such manner at his sole expense repair maintain and keep in good repair and condition the fire fighting and protection installations in or appertaining to his Phase 2 Residential Unit including but not limited to fire rated resistant wall, smoke detector and fire alarm of the automatic fire detection system and sprinkler pipes and sprinkler heads of the sprinkler system serving such Phase 2 Residential Unit with open kitchen exclusively and when necessary replace any part or parts thereof which require replacement to the satisfaction of the relevant Government department(s). The Owner and resident of any Phase 2 Residential Unit with open kitchen shall comply with the following fire safety provisions to the satisfaction of the relevant Government department(s) and the Manager:

- (i) addressable smoke detectors provided at the common lobby outside the Phase 2 Residential Units shall not be removed or tampered or obstructed;
- (ii) addressable smoke detectors with sounder base provided inside the Phase 2 Residential Units shall not be removed or tampered or obstructed;
- (iii) sprinkler head provided at the ceiling immediately above the open kitchen area shall not be removed or tampered or obstructed;
- (iv) the full height wall having a fire resistance rating of not less than -/30/30 adjacent to the exit door of the Phase 2 Residential Unit shall not be removed or tampered;
- (v) self-closing devices of main entrance door of Phase 2 Residential Units shall not be removed;

- (vi) the fire safety provisions mentioned in (i), (ii) and (iii) above shall be subject to annual check at the cost and expense of the Owner of the Phase 2 Residential Unit with open kitchen conducted by the fire service installation contractor registered with the Fire Services Department appointed by the Manager (“RFSIC”);
- (vii) the Owners and residents of the Phase 2 Residential Units shall allow access for the RFSIC to carry out annual check, maintenance and inspection of the fire safety provisions in the Phase 2 Residential Units;
- (viii) maintenance and inspection work of the fire safety provisions mentioned in (i), (ii) and (iii) above with appropriate maintenance procedures shall be carried out, at the cost and expense of the Owner of the Phase 2 Residential Unit with open kitchen, by RFSIC who shall be responsible for issuance of the relevant maintenance certificate (F.S. 251) to prove the function of such fire safety provisions.

(b) The Owner or residents of any Phase 2 Residential Unit with open kitchen shall at his own costs and expenses observe and comply with the Fire Safety Management Plan and the fire safety provisions mentioned in sub-clauses (a)(i) to (a)(viii) of this Clause and any guideline or direction to be issued or given by the Manager from time to time relating to the implementation of the Fire Safety Management Plan and shall ensure his tenants and other occupiers of his Phase 2 Residential Unit observe and comply with the same.

(c) The Manager shall have the power to implement and/or monitor proper implementation of the Fire Safety Management Plan (including but not limited to providing staff training including the course of actions to be carried out by the security officer/security guard, carrying out fire drill annually and affixing permanent notice at Phase 2 Residential Common Areas (such as in lift lobbies forming parts of Phase 2 Residential Common Areas and on notice board within Phase 2 Residential Common Areas) to remind the residents not to remove or demolish any fire safety provision) by the Owners whose Phase 2 Residential Units contain approved open kitchen design in accordance with the Fire Safety Management Plan and to enter into the relevant Phase 2 Residential Units to implement the Fire Safety Management Plan and/or to take such measures and precautions as may be required to prevent any breach by any Owners in respect of the Fire Safety Management Plan in Phase 2 Residential Units. All cost and expenses incurred by the Manager in

connection with the implementation and/or monitoring of the Fire Safety Management Plan shall be borne by the Owner(s) of the relevant Phase 2 Residential Unit(s) with open kitchen.

(d) Within one month of the date of this Deed, MTR shall deposit a full copy of the Fire Safety Management Plan in the management office in Phase 2 for inspection by all Owners of Phase 2 free of charge and taking copies upon payment of a reasonable charge. All charges received shall be credited to the relevant account of the Special Fund for Phase 2.

Curtain walls and casement windows

6. The Owner of any Phase 2 Residential Unit shall be responsible for the cleaning of the internal surface of the curtain walls (including the openable windows and/or the non-openable windows installed therein or thereto) enclosing his Unit. The Owner of any Phase 2 Residential Unit shall be responsible for the repair, maintenance and replacement works of the openable windows (including any maintenance windows) installed in or to any curtain wall enclosing his Unit and the frames enclosing the glass panels of the openable windows, glass panels, hinges, locks, handles, cast-in anchors, gasket, window sealant and such other components of such openable windows and shall only engage contractors nominated and approved by the Manager to carry out such works. The Owner of any Phase 2 Residential Unit shall also be responsible for the repair, maintenance and replacement of the casement windows (whether openable or not) belonging to his Unit. The Owners of the Phase 2 Residential Units shall not object and shall render full cooperation to the Manager for the purpose of cleaning the external surfaces and carrying out any works with regards to the curtain wall. When the Manager carries out cleaning of the external surface of the curtain walls, the Manager shall have the right to clean the external surface of the openable windows in the curtain walls as well and the costs and expenses incurred in connection therewith shall be paid from the management fund in respect of the Phase 2 Residential Common Areas.

Ownership and maintenance of Non-Common EV Facilities

7. (a) Each Owner of the Phase 2 Car Parking Space shall at his own cost and expense be responsible for the operation, maintenance, inspection, security, repair, replacement and renewal of the Non-Common EV Facilities serving his Phase 2 Car Parking Space exclusively and the ownership of all such facilities shall belong to him. Each Owner of the Phase 2 Car Parking Space shall indemnify the Owners or occupiers of other Units for his failure to observe and comply with the provisions of this Clause.

(b) Without prejudice to the generality of sub-clause (a) above, if any Owner of Phase 2 Car Parking Space shall fail to repair, maintain, replace or renew the Non-Common EV Facilities serving his Phase 2 Car Parking Space exclusively in accordance with sub-clause (a) above and it has caused damage or, in the reasonable opinion of the

Manager, danger to the other part of Phase 2 or the Owners or occupiers of the other Units, the Manager shall have the right and power, but not obliged, to carry out such repairs, maintenance, replacement or renewal works to the relevant Non-Common EV Facilities and make good all damage (if any) caused by the Owner's failure to repair, maintain, replace or renew as the Manager shall in its absolute discretion see fit and all the costs and expenses incurred by the Manager in connection therewith shall be recoverable from the Owner of the relevant Phase 2 Car Parking Space as a debt.

(c) The appearance and standards of all replaced Non-Common EV Facilities installed by an Owner of Phase 2 Car Parking Space shall be consistent and compatible with the appearance and standards of the original Non-Common EV Facilities installed for his Phase 2 Car Parking Space.

Compliance with Ordinances, etc. in respect of Non-Common EV Facilities

8. Each Owner of Phase 2 Car Parking Space shall at his own costs and expense at all times:-

(a) observe and comply with all Ordinances, by-laws and Government regulations of Hong Kong and guidelines and directions as may be issued by the Environment Bureau or the Electrical and Mechanical Services Department or all other Government authorities from time to time and all the Building Rules and Phase 2 House Rules (if any) as may be made and all such directions (if any) as may be given by the Manager from time to time in relation to the installation, use, operation, maintenance, repair, replacement and/or renewal of the Non-Common EV Facilities or any part thereof serving his Phase 2 Car Parking Space exclusively including but not limited to any works to be carried out thereat and control of the consistent appearance of the Non-Common EV Facilities;

(b) take good care and such precautions as may be necessary in the use or operation of the Non-Common EV Facilities or any part thereof serving his Phase 2 Car Parking Space exclusively so as to avoid any loss, damage, nuisance or annoyance to Owners or occupiers of the other Units; and

(c) indemnify the Owners or occupiers of the other Units for his failure to observe or comply with the provisions of this Clause.

Compliance with Ordinances, etc. in respect of EV Facilities for Visitors' Car Parking Spaces in Phase 2

9. The Owners of the Phase 2 Residential Units shall ensure that the bona fide guests, visitors and invitees of the residents of the Phase 2 Residential Units shall at all times:-

(a) observe and comply with all Ordinances, by-laws and Government regulations of Hong Kong and guidelines and directions as may be issued by the Environment Bureau or the Electrical and

Mechanical Services Department or any Government authorities from time to time and all the Building Rules (if any) as may be made and all such directions (if any) as may be given by the Manager from time to time in relation to the use or operation of the EV Facilities for Visitors' Car Parking Spaces in Phase 2;

(b) take good care and such precautions as may be necessary in the use of the EV Facilities for Visitors' Car Parking Spaces in Phase 2 or any part thereof so as to avoid any loss, damage, nuisance or annoyance to Owners or occupiers of the other Units; and

(c) indemnify the Owners or occupiers of the other Units for their failure to observe or comply with the provisions of this Clause.

Phase 2 Noise Mitigation Measures

10. All Owners of Phase 2 Residential Units shall observe and comply with all Ordinances, by-laws and Government regulations of Hong Kong and guidelines and directions as may be issued by any Government authorities or the Manager from time to time in relation to use or maintenance or operation of the Phase 2 Noise Mitigation Measures and no Owners shall do or permit any act or thing to be done which may in any way damage or affect the Phase 2 Noise Mitigation Measures.

Electricity supply

11. (a) For provision of electricity services to Phase 2, The Hongkong Electric Company Limited, its employees and contractors shall have the right to operate the equipment and facilities of The Hongkong Electric Company Limited installed in the transformer rooms in Phase 2 PROVIDED THAT the Manager shall at all times be responsible for the management and control of the transformer rooms in Phase 2.

(b) The Owners of Units in Phase 2 shall, at their own cost and expense acting through the Manager, be responsible for the repair and maintenance of the transformer rooms, cable accommodations and all associated facilities (excluding the equipment and facilities of The Hongkong Electric Company Limited) for provision of electricity services to Phase 2 and be responsible for any reinstatement work to the transformer rooms and cable accommodations rendered necessary by the installation, repair or replacement of the equipment and facilities of The Hongkong Electric Company Limited therein.

Maintenance of private hose reels

12. (a) Each Owner of the Phase 2 Residential Unit with hose reel and associated manual fire alarm system at its roof shall in such manner at his sole expense repair maintain and keep in good repair and condition the said hose reel and associated manual fire alarm system and when necessary replace any part or parts thereof which require replacement to the satisfaction of the relevant Government department(s).

(b) The said hose reel and associated manual fire alarm system shall be subject to annual check, maintenance and inspection at the

cost and expense of the Owner of the relevant Phase 2 Residential Unit with hose reel and associated manual fire alarm system at its roof conducted by the RFSIC, and the Owner and resident(s) of such Phase 2 Residential Unit shall allow the RFSIC to enter into his Phase 2 Residential Unit for the purposes of carrying out the same. The Manager shall assist the Owners of such Phase 2 Residential Units to carry out such annual check, maintenance and inspection, and submit the relevant maintenance certificates (F.S. 251) to Fire Services Department.

(c) The Manager shall have the power to enter into the relevant Phase 2 Residential Unit with hose reel and associated manual fire alarm system at its roof to take such measures and precautions as may be required if the Owner of the same fails to perform his obligations mentioned in (a) and (b) above. All cost and expenses incurred by the Manager in connection therewith shall be borne by the Owner of the relevant Phase 2 Residential Unit.

SECTION E

MEETINGS OF THE OWNERS OF PHASE 2

Meetings of the Owners

1. From time to time as occasion may require there shall be meetings of the Owners of Phase 2 to discuss and decide matters concerning Phase 2 as hereinafter mentioned and in regard to such meetings the provisions of this Section shall apply. The procedure at a meeting of the Owners of Phase 2 shall be as is determined by the Owners of Phase 2.

Annual Meeting

2. (a) The Manager shall convene a meeting of the Owners of Phase 2 as soon as possible but in any event not later than nine months after the date of this Deed (and to convene further and subsequent meetings if required) to appoint a Phase 2 Owners' Sub-Committee and the Chairman and Secretary thereof.

(b) One such meeting, to be known as the Annual Meeting, shall be held as soon as practicable after the end of each financial year (as defined by Clause 3 of Section J of the Principal Deed) for the purposes of receiving the Manager's report and an income and expenditure account and balance sheet for the previous financial year in respect of Phase 2, and transacting any other business of which due notice is given in the notice convening the meeting.

Convening of Meeting

3. A meeting of the Owners of Phase 2 may be convened by:

- (a) the Phase 2 Owners' Sub-Committee;
- (b) the Manager; or
- (c) an Owner of Phase 2 appointed to convene such a meeting by the Owners of Phase 2 of not less than 5% of the Shares attributable to Phase 2 in aggregate.

Notice

4. The person convening the meeting of the Owners of Phase 2 shall, at least 14 days before the date of the meeting, give notice of the meeting to each Owner of Phase 2. The notice of meeting shall specify the date, time and place of the meeting and the resolutions (if any) that are to be proposed at the meeting. The notice of meeting may be given:

- (a) by delivering it personally to the Owners;
- (b) by sending it by post to the Owner at his last known address; or
- (c) by leaving it at the Owner's Residential Unit or depositing it in the letter box for that Residential Unit.

Notice of meeting shall also be given to MTR as the Owner of the Station and the Depot as aforesaid and if the matter or matters to be discussed may

in the opinion of MTR as the Owner of the Station and the Depot affect or have an impact on the Station and/or the Depot and/or be ancillary or pertaining thereto, MTR as the Owner of the Station and the Depot shall be entitled to attend the meeting.

Quorum

5. (a) No business shall be transacted at any meeting unless a quorum is present when the meeting proceeds to business.

(b) 10% of the Owners of Phase 2 present in person or by proxy shall be a quorum at any meeting. For the purpose of this sub-clause, the reference to "10% of the Owners of Phase 2" shall be construed as a reference to 10% of the number of persons who are Owners of Phase 2 without regard to their ownership of any particular percentage of the total number of Shares into which Phase 2 is divided and not be construed as the Owners of 10% of the Shares in Phase 2 in aggregate.

Chairman

6. A meeting of the Owners of Phase 2 shall be presided over by the Chairman of the Phase 2 Owners' Sub-Committee or if the meeting is convened under Clause 3(b) or 3(c) of this Section, the person convening the meeting.

Minutes

7. The Chairman shall cause the Manager to keep a record of the persons present at the meeting and the proceedings thereof.

Voting

8. (a) At a meeting of the Owners of Phase 2

- (i) an Owner shall have one vote in respect of each Share he owns;
- (ii) an Owner may cast a vote personally or by proxy;
- (iii) where 2 or more persons are the co-Owners of a Share, the vote in respect of the Share may be cast:
 - (I) by a proxy jointly appointed by the co-Owners;
 - (II) by a person appointed by the co-Owners from amongst themselves; or
 - (III) if no appointment is made under Clauses 8(a)(iii)(I) or 8(a)(iii)(II) of this Section, either by one of the co-Owners personally or by a proxy appointed by one of the co-Owners;
- (iv) where 2 or more persons are the co-Owners of a Share and more than one of the co-Owners seek to cast a vote in respect of the Share, only the vote that is cast, whether personally or by proxy, by the co-Owner whose name, in order of priority, stands highest in relation to that Share in the

register kept at the Land Registry shall be treated as valid;

(v) if there is an equality of votes the person presiding over the meeting shall have in addition to a deliberative vote, a casting vote.

(b) An instrument appointing a proxy shall be in the form set out in Form 1 in Schedule 1A of the Ordinance, and

(i) shall be signed by the Owner; or

(ii) if the Owner is a body corporate, shall, notwithstanding anything to the contrary in its constitution, be impressed with the seal or chop of the body corporate and signed by a person authorized by the body corporate in that behalf.

(c) The instrument appointing a proxy shall be lodged with the Chairman of the Phase 2 Owners' Sub-Committee or, if the meeting is convened under Clauses 3(b) or 3(c) of this Section, the person convening the meeting at least 48 hours before the time for the holding of the meeting.

(d) A proxy appointed by an Owner to attend and vote on behalf of the Owner shall, for the purposes of the meeting, be treated as being the Owner present at the meeting.

(e) For the avoidance of doubt, there shall not be any votes attaching to Shares allocated to the Estate Common Areas in Phase 2 and the Estate Common Services and Facilities in Phase 2, the Residential Development Common Areas in Phase 2 and the Residential Development Common Services and Facilities in Phase 2, the Phase 2 Common Areas and the Phase 2 Common Services and Facilities, the Phase 2 Residential Common Areas and the Phase 2 Residential Common Services and Facilities and the Phase 2 Car Park Common Areas and the Phase 2 Car Park Common Services and Facilities nor shall such Shares be taken into account for the purpose of counting a quorum of any meeting, and the Manager shall not be entitled to vote as trustee of the relevant Owners of the Shares allocated thereto at any meeting of the Owners of Phase 2.

Resolutions binding on Owners

9. (a) Any resolution on any matter concerning Phase 2, save only those matters referred to in Clause 11 of this Section, passed at a duly convened meeting by a majority vote of the Owners of Phase 2 present in person or by proxy and voting shall be binding on all the Owners of Phase 2 PROVIDED THAT:-

(i) the notice convening the meeting shall have been duly given and shall have specified the intention to propose a resolution concerning such matter;

- (ii) no resolution purporting to be passed at any such meeting concerning any matter not mentioned in such notice shall be valid;
- (iii) no resolution shall be valid to the extent that it purports to alter or amend the provisions of this Deed or is inconsistent therewith save as herein specifically provided;
- (iv) no resolution shall be valid to the extent that it is in conflict with or contrary to any order ruling or judgment of the Hong Kong courts or any mandatory provision of any statute;
- (v) no resolution (other than a resolution pursuant to Section D of the Principal Deed) shall contravene Clause 9(a)(v) of Section F of the Principal Deed;
- (vi) any resolution on matters or issues which in the reasonable opinion of MTR as the Owner of the Station and the Depot may affect or have an impact on the Station and/or the Depot and/or be ancillary or pertaining thereto, shall be subject to the agreement of MTR as the Owner of the Station and the Depot; and
- (vii) no resolution shall damage, interfere with, obstruct or endanger the construction, use, operation, maintenance or safety of the Mass Transit Railway, the Mass Transit Railway Structures and Installations, the Station or the Depot or any part thereof.

(b) A resolution may be passed as to the manner in which the powers and duties conferred on the Manager by the Principal Deed or this Deed are to be exercised or carried out but no such resolution shall invalidate any prior act of the Manager which would have been valid had that resolution not been passed.

Accidental omission of notice

10. The accidental omission to give notice as aforesaid to any Owner shall not invalidate the proceedings at any meeting and any resolution passed thereat.

Resolutions requiring special majority

11. Notwithstanding the provisions of Clause 9 of this Section, no resolution in respect of the matters referred to in Section D of the Principal Deed shall be valid unless passed by the majorities specified therein.

Audit of annual accounts

12. Prior to the formation of the Owners' Corporation, the Owners of Phase 2 at a meeting of the Owners of Phase 2 convened under this Deed shall have the power to require the annual accounts of Phase 2 to be audited by an independent auditor of their choice.

SECTION F

PHASE 2 OWNERS' SUB-COMMITTEE

Number of members

1. (a) The Phase 2 Owners' Sub-Committee shall consist of five (5) members.

(b) The members of the Phase 2 Owners' Sub-Committee shall be made up of :

(i) one (1) member from each Tower as representatives of the Phase 2 Residential Development; and

(ii) one (1) member as representative of the Phase 2 Car Park.

(c) For the purpose of this Section F, "each Tower" shall mean each of Tower 1 (1A), Tower 1 (1B), Tower 2 (2A) and Tower 2 (2B).

Quorum

2. (a) A quorum for meetings of the Phase 2 Owners' Sub-Committee shall be at least three (3) members.

(b) Provided a quorum exists, the Phase 2 Owners' Sub-Committee shall be entitled to act and continue to act notwithstanding that the number of its members falls below five (5) or that for any reason less than five (5) members are elected in the manner herein provided.

Eligibility for appointment

3. The following persons shall be eligible for appointment to the Phase 2 Owners' Sub-Committee :-

(a) Any Owner (in case of two or more co-Owners of a Unit, only one of them) of a Unit in Phase 2.

(b) The duly authorised representative (PROVIDED THAT such authorisation shall be in writing addressed to the Phase 2 Owners' Sub-Committee and may be revoked at any time on notice in writing given to the Phase 2 Owners' Sub-Committee), in his place, of any Owner of a Unit in Phase 2, being:

(i) the representative of an Owner which is a body corporate; or

(ii) the husband, wife or adult family member of an Owner PROVIDED THAT such husband, wife or adult family member resides in or occupies such Owner's Unit.

Election of members

4. (a) The Manager shall convene a meeting of the Owners of Phase 2 comprising :-

- (i) each Tower in the Phase 2 Residential Development; and
- (ii) the Phase 2 Car Park;

the first such meeting to be convened within nine months of the date of this Deed (and to call further and subsequent meetings if required), which meeting and each subsequent Annual Meeting (as referred to in sub-clause (b) below) must appoint the members of the Phase 2 Owners' Sub-Committee and the Chairman and Secretary of the Phase 2 Owners' Sub-Committee.

(b) One such meeting, to be known as the Annual Meeting, shall be held as soon as practicable after the end of each financial year (as defined by Clause 3 of Section J of the Principal Deed) for the purposes of receiving the Manager's report and an income and expenditure account and balance sheet for the previous financial year in respect of Phase 2, and transacting any other business of which due notice is given in the notice convening the meeting.

(c) At the first meeting and at each subsequent Annual Meeting :

- (i) the Owners of each Tower in the Phase 2 Residential Development shall elect one (1) representative of that Tower to the Phase 2 Owners' Sub-Committee;
- (ii) the Owners of the Phase 2 Car Parking Spaces shall elect one (1) representative to the Phase 2 Owners' Sub-Committee

PROVIDED THAT no individual (whether in the capacity of an Owner or the duly authorised representative of an Owner) shall be appointed as the representative of more than one Tower in the Phase 2 Residential Development or as the representative of any Tower in the Phase 2 Residential Development and the Phase 2 Car Parking Spaces to the Phase 2 Owners' Sub-Committee at the same time.

Officers

5. (a) The officers of the Phase 2 Owners' Sub-Committee shall comprise :-

- (i) a Chairman;
- (ii) a Secretary;
- (iii) such other officers (if any) as the Phase 2 Owners' Sub-Committee may from time to time elect.

(b) All casual vacancies in the officers shall be filled by election or appointment by the members of the Phase 2 Owners' Sub-Committee from among them as they may from time to time determine.

(c) A meeting of the Phase 2 Owners' Sub-Committee shall be presided over by:

- (i) the Chairman; or
- (ii) in the absence of the Chairman, a member of the Phase 2 Owners' Sub-Committee appointed as chairman for that meeting.

Tenure of office

6. (a) Members of the Phase 2 Owners' Sub-Committee shall hold office until the Annual Meeting of Owners of Phase 2 next following their appointment or election PROVIDED THAT if the office of the retiring members or any of them is not filled, or if in any year no Annual Meeting is held, such members or member shall continue in office until the next Annual Meeting.

(b) Retiring members of the Phase 2 Owners' Sub-Committee shall be eligible for re-election or re-appointment as appropriate.

(c) A member of the Phase 2 Owners' Sub-Committee shall nevertheless cease to hold office if :

- (i) he resigns by notice in writing to the Phase 2 Owners' Sub-Committee;
- (ii) he ceases to be eligible;
- (iii) his authority is revoked by the Owners he represents;
- (iv) he, or the Owner(s) he represents, becomes bankrupt or insolvent or is convicted of a criminal offence other than a summary offence not involving dishonesty;
- (v) he becomes incapacitated by physical or mental illness;
- (vi) he, or the Owner(s) he represents, has defaulted in paying his contribution towards the Management Charges for more than one month;

(vii) he, or the Owner(s) he represents, fails to observe and perform the provisions of the Principal Deed or this Deed.

(d) Any one or more members of the Phase 2 Owners' Sub-Committee may be removed from office by a resolution of the Owners of Units of the part of Phase 2 which he represents at an Extraordinary Meeting convened for the purpose by the Manager, the Phase 2 Owners' Sub-Committee or by Owners of Units in Phase 2 entitled to attend and vote at any such meeting who in the aggregate have vested in them not less than 20% of the Shares attributable to the part of Phase 2 which the member represents and at any such Meeting, new members of the Phase 2 Owners' Sub-Committee may be appointed in the place of those removed from office.

Votes of members

7. Members of the Phase 2 Owners' Sub-Committee shall be entitled to one vote each at Phase 2 Owners' Sub-Committee meetings and resolutions shall be passed by a simple majority of those present in person or by proxy and voting. In the case of equality of voting the Chairman shall have a second or casting vote. Proxies shall be in writing and shall be deposited with the Chairman of the meeting prior to the commencement of the meeting. No resolution of the Phase 2 Owners' Sub-Committee shall contravene Clause 1(e) of Section G of the Principal Deed.

Power to make rules

8. The Phase 2 Owners' Sub-Committee shall have full power to determine where, when and how often it shall meet and to make rules and bye-laws regulating the conduct and procedure of its meetings and the performance of its duties and obligations PROVIDED THAT no such regulation or bye-law shall be contrary to or inconsistent with the provisions of this Deed or the Principal Deed.

Manager to be invited

9. The Phase 2 Owners' Sub-Committee shall invite the Manager to any meeting called by giving the Manager at least seven (7) days' notice in writing of the date, time and place of the meeting and the matters to be discussed.

Power to call meeting

10. The Chairman, any two members of the Phase 2 Owners' Sub-Committee or the Manager may at any time convene a meeting of the Phase 2 Owners' Sub-Committee PROVIDED THAT the person or persons convening the meeting shall, at least 7 days before the date of meeting, give to each member of the Phase 2 Owners' Sub-Committee notice of the date, time and place of the meeting and the resolutions (if any) that are to be proposed at the meeting. The notice of a meeting may be given:

- (a) by delivering it personally to the member;
- (b) by sending it by post to the member at his last known address;

- (c) by leaving the notice at the member's Residential Unit or depositing the notice in the letter box for that Residential Unit.

SECTION G

PHASE 2 HOUSE RULES

**Phase 2 House Rules
first in force**

1. The Phase 2 House Rules set out in the Fourth Schedule hereto shall be deemed to have come into force on the date of this Deed in respect of Phase 2 and shall remain in force until revoked or amended as hereinafter provided.

**Making and
amendment of
Phase 2 House Rules**

2. The Manager shall have power from time to time to make, revoke and amend the Phase 2 House Rules regulating the use, occupation, maintenance and environmental control of Phase 2 and the conduct of persons occupying, visiting or using the same and the Phase 2 House Rules shall not be inconsistent with or contravene the provisions of the Principal Deed, this Deed, the Ordinance or the Government Grant PROVIDED THAT if the Phase 2 Owners' Sub-Committee is in existence, the Phase 2 House Rules shall only be made, revoked or amended by the Manager with the prior approval of the Phase 2 Owners' Sub-Committee.

**Phase 2 House Rules to
be posted on notice
boards**

3. Copies of the Phase 2 House Rules from time to time in force shall be posted on the public notice boards in Phase 2.

**Phase 2 House Rules not
adversely affect
Government
Accommodation**

4. The Phase 2 House Rules shall not contravene any provisions of the Principal Deed, and in particular shall not in any way affect the rights, easements and privileges set out in Clause 2 of Part I of the Second Schedule to the Principal Deed.

SECTION H

INTERPRETATION AND MISCELLANEOUS

**Marginal notes,
headings and index**

1. The marginal notes, headings and index are intended for guidance only and do not form part of this Deed nor shall any of the provisions of this Deed be construed or interpreted by reference thereto or in any way affected or limited thereby.

Plurals and genders

2. In this Deed (if the context so permits or requires) words importing the singular number only shall include the plural number and vice versa, words importing the masculine gender only shall include the feminine gender and neuter gender and words importing persons shall include corporations.

Service of notices

3. (a) All notices or demands required to be served hereunder shall be sufficiently served if addressed to the party intended to receive the same and sent by prepaid post to or left at the Residential Unit of which the party to be served is the Owner notwithstanding that such party shall not personally occupy such Residential Unit PROVIDED THAT where notice is to be given to an Owner who is a mortgagee, such notice shall be served on the mortgagee, if a Company, at its last known place of business or, if an individual at his last known residence in Hong Kong.

(b) All notices required to be given to the Manager under this Deed shall be properly served if sent by prepaid post to or left at its registered office or the management office in Phase 2 or such other address as may be notified by the Manager from time to time.

(c) All notices required to be given to the Phase 2 Owners' Sub-Committee shall be properly served if sent by prepaid post to or left with the Chairman or Secretary of the Phase 2 Owners' Sub-Committee at his usual residential address.

(d) All non-resident Owners shall provide the Manager with an address within Hong Kong for service of process and notices to be given pursuant to this Deed.

**Covenants to run with
the Land**

4. The mutual covenants herein contained are intended to be annexed to and shall run with the Land and each and every Share therein and shall be enforceable by and against the Owner for the time being of any such Share both as to the benefit and burden of such covenants, and any ordinance or other statutory enactment for the time being in force concerning the enforcement of mutual covenants relating to land or buildings shall apply to this Deed.

Chinese Translation

5. MTR shall at its own costs and expenses provide a direct translation in Chinese of this Deed and deposit a copy of this Deed and its

Chinese translation at the management office of Phase 2 within one month after the date of this Deed. Copies of this Deed and its Chinese translation shall be made available for inspection by all Owners of Phase 2 free of costs at the management office of Phase 2. A copy of this Deed or its Chinese translation or both shall be supplied by the Manager to an Owner of Phase 2 on request and upon payment of a reasonable charge. All charges received shall be credited to the relevant account of the Special Fund for Phase 2. In the event of dispute as to the effect or construction of this Deed and its Chinese translation, the English text of this Deed shall prevail.

The Ordinance

6. (a) Nothing in this Deed shall prejudice or in any way be construed or constructed so as to prejudice or exclude the operation of the provisions of the Ordinance and the Schedules thereto.

(b) MTR shall deposit a copy of Schedules 7 and 8 to the Ordinance (English and Chinese versions) in the management office in Phase 2 for reference by all Owners of Phase 2 free of costs and for taking copies at their own expense and upon payment of a reasonable charge. All charges received must be credited to the relevant account of the Special Fund for Phase 2.

Phase 2 Works and Installations

7. (a) MTR shall compile for the reference of the Owners of Phase 2 and the Manager a maintenance manual for the Phase 2 Works and Installations ("**the Works Manual**") setting out the following details :

- (i) as-built record plans of the building and services installations together with the necessary technical information (such as specifications of materials and design standard) for maintenance of all facilities and equipment;
- (ii) all warranties and guarantees provided by contractors (together with the names of the companies providing the warranty and the contact telephone numbers) in respect of all facilities and equipment;
- (iii) recommended maintenance strategy and procedures;
- (iv) a list of items of the Phase 2 Works and Installations requiring routine maintenance;
- (v) recommended frequency of routine maintenance inspection;
- (vi) checklist and typical inspection record sheets for routine maintenance inspection; and
- (vii) recommended maintenance cycle of the Phase 2 Works and Installations.

(b) MTR shall deposit a full copy of the Works Manual in the management office in Phase 2 within one month after the date of this Deed for inspection by all Owners of Phase 2 free of charge and taking copies at their own expense and on payment of a reasonable charge which shall be credited to the relevant account(s) of the Special Fund for Phase 2.

(c) The Owners of Phase 2 shall at their own expense inspect, maintain and carry out all necessary works for the maintenance of Phase 2 and their own Units including the Phase 2 Works and Installations.

(d) All costs incidental to the preparation of the schedule for the Phase 2 Works and Installations and the Works Manual shall be borne by MTR.

(e) The Owners of Phase 2 may, by a resolution of Owners at an Owners' meeting of Phase 2 convened under this Deed, decide on any necessary revisions to be made to the schedule for the Phase 2 Works and Installations and the Works Manual from time to time as they shall deem fit, in which event the Manager shall procure from a qualified professional or consultant the revised schedule for the Phase 2 Works and Installations and the revised Works Manual within such time as may be prescribed by the Owners of Phase 2 in an Owners' meeting of Phase 2 convened under this Deed. All costs incidental to the preparation of the revised schedule for the Phase 2 Works and Installations and the revised Works Manual shall be paid out of the relevant account(s) of the Special Fund for Phase 2.

(f) The Manager shall deposit the revised Works Manual in the management office in Phase 2 within one month after the date of its preparation for inspection by all Owners of Phase 2 free of charge and taking copies at their own expense and on payment of a reasonable charge which shall be credited to the relevant account(s) of the Special Fund for Phase 2.

**Paragraphs 7(7) and 7(8)
of Schedule 7 to the
Ordinance**

8. (a) If any person has given an undertaking in writing to, or has entered into an agreement with, the Government to manage or be responsible for the management of the Estate, and the Owners' Corporation has appointed a Manager under Clause 2(j)(ii) of Section H of the Principal Deed, the Owners' Corporation shall be deemed to have given to that person an instrument of indemnity under which the Owners' Corporation shall be liable to indemnify that person in respect of any act or omission by the Manager appointed under Clause 2(j)(ii) of Section H of the Principal Deed that may otherwise render that person liable for a breach of that undertaking or agreement.

(b) Clauses 2(d), (e), (f), (g), (h), (i) and (j) of Section H of the Principal Deed and sub-clause (a) of this Clause are subject to any

notice relating to the Estate that may be published by the Secretary for Home Affairs under section 34E(4) of the Ordinance but does not apply to any single manager referred to in that section.

THE FIRST SCHEDULE
PART I
ALLOCATION OF SHARES

		<u>No. of Shares</u>
<u>Phase 2 Residential Units</u>		
Tower 1 (1A)	88,652	
Tower 1 (1B)	98,553	
Tower 2 (2A)	121,782	
Tower 2 (2B)	88,993	397,980
<u>Phase 2 Car Parking Spaces</u>		
96 Car Parking Spaces (Nos.1 to 108 on 3 rd Floor) (Nos.4, 13, 14, 24, 34, 44, 54, 64, 74, 84, 94 & 104 omitted) (125 Shares each)	12,000	
5 Motor Cycle Parking Spaces (Nos.M1 to M6 on 3 rd Floor) (No.M4 omitted) (24 Shares each)	120	12,120
<u>Common Areas and Common Services and Facilities in Phase 2</u>		
- Estate Common Areas in Phase 2 and Estate Common Services and Facilities in Phase 2		
- Residential Development Common Areas in Phase 2 and Residential Development Common Services and Facilities in Phase 2		
- Phase 2 Common Areas and Phase 2 Common Services and Facilities		
- Phase 2 Residential Common Areas and Phase 2 Residential Common Services and Facilities		
- Phase 2 Car Park Common Areas and Phase 2 Car Park Common Services and Facilities		
		45,647
Total number of Shares :		455,747

Allocation of Shares to each Phase 2 Residential Unit

Tower 1 (1A)

Floor \ Unit	A	B	C	D	E
5/F	1197 *	854 *	475 *	712 *	467 *
6/F – 31/F	1207	868	487	699	462
32/F	1874 #^	1167 #^%	-	-	-

- * with garden(s) appertaining thereto
- # with flat roof(s) appertaining thereto
- ^ with roof immediately thereabove
- % with stairhood appertaining thereto

Note: There are no designations of 4/F, 13/F, 14/F and 24/F in Tower 1 (1A).
9/F is the refuge floor.

Total no. of Shares allocated to the Phase 2 Residential Units in Tower 1 (1A): 88,652

Tower 1 (1B)

Floor \ Unit	A	B	C	D	E	F
5/F	1311 *	871 *	553 *	441 *	488 *	426 *
6/F – 20/F	1319	875	547	447	486	432
21/F – 31/F	1319	875	548	447	487	431
32/F	1968 #^	1126 ^	1027 ^%	-	-	-

- * with garden(s) appertaining thereto
- # with flat roof(s) appertaining thereto
- ^ with roof immediately thereabove
- % with stairhood appertaining thereto

Note: There are no designations of 4/F, 13/F, 14/F and 24/F in Tower 1 (1B).
9/F is the refuge floor.

Total no. of Shares allocated to the Phase 2 Residential Units in Tower 1 (1B): 98,553

Tower 2 (2A)

Floor \ Unit	A	B	C	D	E	F
5/F	910 *	784 *	802 *	882 *	298	538 *
6/F – 37/F	887	782	791	856	318	561
38/F	1512 #^%	1674 #^	1117 #^%	-	-	-

- * with garden(s) appertaining thereto
- # with flat roof(s) appertaining thereto
- ^ with roof immediately thereabove
- % with stairhood appertaining thereto

Note: There are no designations of 4/F, 13/F, 14/F, 24/F and 34/F in Tower 2 (2A).
9/F is the refuge floor.

Total no. of Shares allocated to the Phase 2 Residential Units in Tower 2 (2A): 121,782

Tower 2 (2B)

Floor \ Unit	A	B	C	D	E	F	G
5/F	584 *	485 *	406	-	-	-	411
6/F – 8/F	594	506	437	311	514	319	437
10/F – 36/F	594	553	697	-	514	319	437
37/F	1202 ^%@	553	697	-	514	319	437
38/F		1462 #^%	947 ^%	-	-	-	-

- * with garden(s) appertaining thereto
- # with flat roof(s) appertaining thereto
- ^ with roof immediately thereabove
- % with stairhood appertaining thereto
- @ duplex unit

Note: There are no designations of 4/F, 13/F, 14/F, 24/F and 34/F in Tower 2 (2B).
9/F is the refuge floor.

Total no. of Shares allocated to the Phase 2 Residential Units in Tower 2 (2B): 88,993

THE FIRST SCHEDULE
PART II
ALLOCATION OF MANAGEMENT UNITS

		<u>No. of Management Units</u>
<u>Phase 2 Residential Units</u>		
Tower 1 (1A)	88,652	
Tower 1 (1B)	98,553	
Tower 2 (2A)	121,782	
Tower 2 (2B)	88,993	397,980
<u>Phase 2 Car Parking Spaces</u>		
96 Car Parking Spaces (Nos.1 to 108 on 3 rd Floor) (Nos.4, 13, 14, 24, 34, 44, 54, 64, 74, 84, 94 & 104 omitted) (125 Management Units each)	12,000	
5 Motor Cycle Parking Spaces (Nos.M1 to M6 on 3 rd Floor) (No.M4 omitted) (24 Management Units each)	120	12,120
<u>Common Areas and Common Services and Facilities in Phase 2</u>		
- Estate Common Areas in Phase 2 and Estate Common Services and Facilities in Phase 2		
- Residential Development Common Areas in Phase 2 and Residential Development Common Services and Facilities in Phase 2		
- Phase 2 Common Areas and Phase 2 Common Services and Facilities		
- Phase 2 Residential Common Areas and Phase 2 Residential Common Services and Facilities		
- Phase 2 Car Park Common Areas and Phase 2 Car Park Common Services and Facilities		0
Total number of Management Units :		410,100

Allocation of Management Units to each Phase 2 Residential Unit

Tower 1 (1A)

Floor \ Unit	A	B	C	D	E
5/F	1197 *	854 *	475 *	712 *	467 *
6/F – 31/F	1207	868	487	699	462
32/F	1874 #^	1167 #^%	-	-	-

- * with garden(s) appertaining thereto
- # with flat roof(s) appertaining thereto
- ^ with roof immediately thereabove
- % with stairhood appertaining thereto

Note: There are no designations of 4/F, 13/F, 14/F and 24/F in Tower 1 (1A).
9/F is the refuge floor.

Total no. of Management Units allocated to the Phase 2 Residential Units in Tower 1 (1A): 88,652

Tower 1 (1B)

Floor \ Unit	A	B	C	D	E	F
5/F	1311 *	871 *	553 *	441 *	488 *	426 *
6/F – 20/F	1319	875	547	447	486	432
21/F – 31/F	1319	875	548	447	487	431
32/F	1968 #^	1126 ^	1027 ^%	-	-	-

- * with garden(s) appertaining thereto
- # with flat roof(s) appertaining thereto
- ^ with roof immediately thereabove
- % with stairhood appertaining thereto

Note: There are no designations of 4/F, 13/F, 14/F and 24/F in Tower 1 (1B).
9/F is the refuge floor.

Total no. of Management Units allocated to the Phase 2 Residential Units in Tower 1 (1B): 98,553

Tower 2 (2A)

Unit \ Floor	A	B	C	D	E	F
5/F	910 *	784 *	802 *	882 *	298	538 *
6/F – 37/F	887	782	791	856	318	561
38/F	1512 #^%	1674 #^	1117 #^%	-	-	-

- * with garden(s) appertaining thereto
- # with flat roof(s) appertaining thereto
- ^ with roof immediately thereabove
- % with stairhood appertaining thereto

Note: There are no designations of 4/F, 13/F, 14/F, 24/F and 34/F in Tower 2 (2A).
9/F is the refuge floor.

Total no. of Management Units allocated to the Phase 2 Residential Units in Tower 2 (2A): 121,782

Tower 2 (2B)

Unit \ Floor	A	B	C	D	E	F	G
5/F	584 *	485 *	406	-	-	-	411
6/F – 8/F	594	506	437	311	514	319	437
10/F – 36/F	594	553	697	-	514	319	437
37/F	1202 ^%@	553	697	-	514	319	437
38/F		1462 #^%	947 ^%	-	-	-	-

- * with garden(s) appertaining thereto
- # with flat roof(s) appertaining thereto
- ^ with roof immediately thereabove
- % with stairhood appertaining thereto
- @ duplex unit

Note: There are no designations of 4/F, 13/F, 14/F, 24/F and 34/F in Tower 2 (2B).
9/F is the refuge floor.

Total no. of Management Units allocated to the Phase 2 Residential Units in Tower 2 (2B): 88,993

THE SECOND SCHEDULE

PART I

EASEMENTS

Right to pass

1. Full right and liberty for the Owner for the time being, his servants, agents, licensees, tenants and lawful occupants :

(a) of a Phase 2 Residential Unit to use, go, pass and repass over and along and upon the Estate Common Areas in Phase 2, the Residential Development Common Areas in Phase 2, the Phase 2 Common Areas and the Phase 2 Residential Common Areas and to use the Estate Common Services and Facilities in Phase 2, the Residential Development Common Services and Facilities in Phase 2, the Phase 2 Common Services and Facilities and the Phase 2 Residential Common Services and Facilities in common with all others having the like right;

(b) of a Phase 2 Car Parking Space to use, go, pass and repass over and along and upon the Estate Common Areas in Phase 2, the Phase 2 Common Areas and the Phase 2 Car Park Common Areas and to use the Estate Common Services and Facilities in Phase 2, the Phase 2 Common Services and Facilities and the Phase 2 Car Park Common Services and Facilities in common with all others having the like right;

for all purposes connected with the proper use and enjoyment of his Unit.

Rights of Owners of the
Phase 2 Car Parking
Spaces

2. (a) Subject to the provisions of Clauses 7 and 8 of Section D of this Deed, the full right and liberty (Subject Always to the rights of the Manager under the Principal Deed and this Deed) for the Owner of a Phase 2 Car Parking Space for the time being at his own cost and expense to install, maintain, repair and replace an electric meter and such associated facilities within the electrical room of the Phase 2 Car Park Common Areas and to lay and/or maintain, repair and replace such cables, base box, socket outlets, protective and security devices within the Phase 2 Car Park Common Areas at such locations and in such manner to be approved by the Manager (including but not limited to the designation of routing and the manner of which such installation, maintenance, repair and replacement is carried out) for the purposes of or in connection with the proper use and enjoyment and operation of the Non-Common EV Facilities serving his Phase 2 Car Parking Space exclusively.

(b) The right for the Owner for the time being and his servants, agents, licensees, tenants and lawful occupants of any Phase 2 Car Parking Space (in common with all other persons having the like right) to pass

through such parts of the Phase 2 Residential Common Areas as may be designated or re-designated by the Manager from time to time for the purpose of access to and from the caretaker's office on the Podium Floor of Phase 2 and the Phase 2 Car Park and to use the Phase 2 Residential Common Services and Facilities for such purpose.

Rights of Owners of the
Phase 2 Residential Units

3. Subject to the terms of the Government Grant and the provisions of Clauses 11 and 12 of the Third Schedule to this Deed, the full right and liberty for the Owner for the time being of a Phase 2 Residential Unit, his servants, agents, licensees, tenants and lawful occupants to use, go, pass and repass over and along and upon the Phase 2 Car Park Common Areas and to use the Phase 2 Car Park Common Services and Facilities in common with all others having the like right for the purposes of access and egress to and from and use of (i) the Visitors' Car Parking Spaces in Phase 2 and (ii) the refuse storage and material recovery chamber forming part of the Phase 2 Residential Common Areas.

THE SECOND SCHEDULE
PART II
EXCEPTIONS AND RESERVATIONS

- | | |
|---|--|
| Rights of other Owners | 1. Easements, rights and privileges set out in Part II of the Second Schedule to the Principal Deed. |
| Rights of other Owners of the Residential Development | 2. Subject to the terms of the Government Grant and the provisions of Clauses 11 and 12 of the Third Schedule to this Deed, the full right and liberty for the Owner for the time being of a Residential Unit, his servants, agents, licensees, tenants and lawful occupants to use, go, pass and repass over and along and upon the Phase 2 Car Park Common Areas and to use the Phase 2 Car Park Common Services and Facilities as may be designated by the Manager from time to time in common with all others having the like right for the purposes of access and egress to and from and use of the Visitors' Car Parking Spaces in Phase 2. |
| Rights of MTR | 3. Without prejudice to the generality of the rights reserved to MTR in Clause 3 of Part II of the Second Schedule to the Principal Deed :-

(a) the right for MTR with all necessary tools, equipment, plant and materials with or without servants, workmen and others at all reasonable times on reasonable prior written notice (except in case of emergency) to enter into and upon any part or parts of Site B (other than the Units sold or assigned by MTR) for the purpose of erecting, providing and constructing footbridges, columns, structural supports and connections including but not limited to the Future Footbridge Associated Structures (as defined in Special Condition No.(12)(b) of the Government Grant) at such point or points or part or parts of Site B as it may require from time to time causing as little disturbance as possible and making good any damage caused thereby; and

(b) the right for MTR with all necessary tools, equipment, plant and materials with or without servants, workmen and others at all reasonable times on reasonable prior written notice (except in case of emergency) to enter into and upon any part or parts of Site B (other than the Units sold or assigned by MTR) for the purpose of providing, constructing and maintaining the Pedestrian Walkway in Phase 2 at such point or points or part or parts of Site B as it may require from time to time causing as little disturbance as possible and making good any damage caused thereby. |

THE THIRD SCHEDULE
RESTRICTIONS AND PROHIBITIONS

- | | |
|---|--|
| Not to partition | 1. Not to partition any Phase 2 Residential Unit or Phase 2 Car Parking Space. |
| User | 2. (a) Not to use or permit or suffer to be used any Phase 2 Residential Unit for any purpose whatsoever other than as a private dwelling.

(b) Not to use or permit or suffer to be used any Phase 2 Car Parking Space other than for the parking of one private motor vehicle or one private motor cycle (as the case may be). |
| Not to make alterations or additions | 3. (a) Other than in exceptional circumstances and subject to the prior written consent of the Manager, not to make any structural alterations or additions or paint the outside of any Phase 2 Residential Unit, alter the exterior window glass, alter or remove the railings or balustrades on any Phase 2 Utility Platform or Phase 2 Balcony, or generally do anything that might alter or affect the external appearance of any Phase 2 Residential Unit.

(b) Not to make any structural alteration which will interfere with or affect the rights of the other Owners. |
| Phase 2 Balconies and Phase 2 Utility Platforms | 4. (a) Not to cause, permit, suffer or allow any Phase 2 Balcony and the covered area underneath such Phase 2 Balcony or any Phase 2 Utility Platform and the covered area underneath such Phase 2 Utility Platform to be enclosed above the safe parapet height other than as under the Approved Plans by any material of whatsoever kind or nature, and to keep and maintain any Phase 2 Balcony or Phase 2 Utility Platform in the design and layout as provided under the Approved Plans.

(b) Not to erect, affix or place or cause or permit or suffer or allow to be erected, affixed or placed any structure or partition of any material whether of a permanent or temporary nature on any Phase 2 Balcony or Phase 2 Utility Platform or any part thereof. |
| Not to hang washing | 5. Not to use or permit or suffer to be used any portion of any Unit or the roofs or flat roofs or garden (if any) held and enjoyed therewith, other than the place provided therein specifically therefor, for the washing or drying of clothes or any similar purpose or in any way which may alter the external appearance of the buildings or cause damage, nuisance, annoyance or inconvenience to the other Owners and occupiers of the Land and the Development PROVIDED THAT drying of clothes is allowed in any Phase 2 Utility Platform below the railing level. |

Not to exhibit signs

6. Not to exhibit in or upon any Phase 2 Residential Unit any name, writing, drawing, signboard, plate, advertisement or placard of any kind.

Not to misuse lavatories

7. Not to use or permit or suffer to be used any water closet or other water apparatus on or in the Land and the Development (including those within the Phase 2 Residential Units) for any purpose other than that for which they are intended and not to throw or permit or suffer to be thrown into any W.C. pan, urinal, basin, sink or other lavatory fitting any foreign or deleterious substance of any kind and to pay the Manager on demand the cost of any breakage, blockage or damage resulting from a breach of this provision. The cost of clearing any blockage and/or making good any breakage or damage resulting from their misuse will be charged to the person responsible or to the Owner of the Unit in which the problem originated.

Not to obstruct Common Areas

8. (a) Not to use or cause or permit or suffer the use of any of the Estate Common Areas in Phase 2, the Residential Development Common Areas in Phase 2, the Phase 2 Common Areas, the Phase 2 Residential Common Areas and the Phase 2 Car Park Common Areas for the purpose of drying laundry (except in the places specifically provided therefor) or hanging or placing or storing any article or thing thereon or therein and not to permit servants (or the children of any servant) or any other person to use the same for loitering or eating.

(b) Not to encumber or obstruct or permit or suffer to be encumbered or obstructed with any boxes, dustbins, packaging goods, rubbish, chattels or other obstruction of any kind or nature any of the Estate Common Areas in Phase 2, the Residential Development Common Areas in Phase 2, the Phase 2 Common Areas, the Phase 2 Residential Common Areas and the Phase 2 Car Park Common Areas and the Manager shall be entitled without notice and at the Owner's expense to remove and dispose of as they see fit any such material aforesaid and the Manager shall not thereby incur any liability to the Owner or any other person whomsoever and each and every Owner hereby agrees to keep the Manager indemnified against all losses, claims, damages or expenses of and against the Manager in respect thereof.

No erection of metal grilles and shutters

9. No Owner shall permit or suffer to be erected, affixed, installed or attached in or on or at the window or windows or door or doors or entrance or entrances of any Phase 2 Residential Unit any metal grille or shutter or gate which shall in any way contravene the regulations of the Fire Services Ordinance (Cap. 95 of the Laws of Hong Kong) or other competent authority concerned from time to time in force and/or which may in any way impede the free and uninterrupted passage over, through and along any of the Phase 2 Residential Common Areas or the Phase 2 Residential Common Services and Facilities and the design of any metal grille or shutter or gate shall, prior to the installation thereof, first be submitted to the Manager for its approval in writing and the subsequent installation shall

follow strictly the approved design and any conditions that may be imposed.

Not to obstruct driveways

10. Not to park in, obstruct or otherwise use or permit or suffer any servant, agent, visitor or licensee to park in, obstruct or otherwise use those areas of the Land and the Development allocated to the parking, movement or access of vehicles or designated as loading and unloading areas otherwise than in accordance with the Phase 2 House Rules from time to time made pursuant to Section G of this Deed or the Building Rules made pursuant to Section K of the Principal Deed.

Visitors' Car Parking Spaces in Phase 2

11. The Visitors' Car Parking Spaces in Phase 2, which form parts of the Residential Development Common Areas in Phase 2, shall be used only for the parking of motor vehicles licensed under the Road Traffic Ordinance (Cap. 374 of the Laws of Hong Kong), any regulations made thereunder and any amending legislation, and belonging to the bona fide guests, visitors or invitees of the residents of the Residential Development.

Parking spaces for disabled persons

12. The parking spaces for disabled persons in the Phase 2 Car Park, which form parts of the Residential Development Common Areas in Phase 2, shall be used only for the parking of motor vehicles by disabled persons as defined in the Road Traffic Ordinance (Cap. 374 of the Laws of Hong Kong), any regulations made thereunder and any amending legislation, and belonging to the residents or occupiers of the Residential Development and their bona fide guests, visitors and invitees.

Loading and unloading bays

13. The 2 loading and unloading bays on the Podium Floor of Phase 2, which form parts of the Phase 2 Residential Common Areas, shall be used only for the purpose of loading and unloading of goods vehicles by the Owners or residents of the Phase 2 Residential Development.

Phase 2 Greenery Areas

14. Not to use the Phase 2 Greenery Areas for any other purpose without the prior consent of the Building Authority.

Flat roofs and/or gardens, etc.

15. Not to do or permit or suffer to be done by his tenants, occupiers or licensees any act, deed, matter or thing or place, erect, affix or install or permit or suffer to be placed, erected, affixed or installed by them any items on or in any Phase 2 Balcony, Phase 2 Utility Platform, flat roof, roof, garden, air-conditioning plinth, planter and/or parapet (if any and forming part of a Phase 2 Residential Unit):

(a) which in any way interferes with or affects or which is likely to interfere with or affect the operation of the gondola at any time in the course of the management and/or the maintenance of the Phase 2 Residential Development;

(b) which affects or is likely to affect the appearance of any parapet wall or glass panel forming part of a Phase 2 Residential Unit; or

(c) which alters or damages or is likely to alter or damage any hard paving area forming part of garden (if any) of a Phase 2 Residential Unit.

Height control and planting requirement

16. (a) Not to plant, grow, place, erect, affix or install or permit or suffer to be planted, grown, placed, erected, affixed or installed by his tenants, occupiers or licensees any plant, tree, furniture or other items on or in any Phase 2 Balcony, Phase 2 Utility Platform, flat roof, roof, garden, air-conditioning plinth, planter and/or parapet (if any and forming part of a Phase 2 Residential Unit) that exceeds the height of the parapet wall/glass panel and/or railing level thereof.

(b) Not to plant or grow or permit or suffer to be planted or grown by his tenants, occupiers or licensees any plant or tree in any garden forming part of a Phase 2 Residential Unit unless planted and carried in the large tank provided at the relevant Phase 2 Residential Unit on completion of the purchase by the first Owner of the relevant Phase 2 Residential Unit or other tank of such size and material to be from time to time specified by the Manager.

THE FOURTH SCHEDULE
PHASE 2 HOUSE RULES

1. (a) The purpose of Phase 2 House Rules is to help maintain and preserve Phase 2 of the Estate as a high quality residential estate. They are for the benefit of all Owners of Phase 2 and residents and occupiers, on whom (together with their tenants, licensees, guests, servants and agents) they are binding.
- (b) The Phase 2 House Rules are supplementary to the Principal Deed and this Deed, the terms of which will prevail in the event of any conflict.
- (c) The Manager is empowered to enforce the Phase 2 House Rules and, from time to time as necessary, to amend or revoke them or make new rules in accordance with Section G of this Deed.
2. (a) The movement and parking of vehicles within Phase 2 is under the control of the Manager and all drivers must comply with directions given by the staff of the Manager.
- (b) The speed limit on Phase 2 is 20 kph.
3. (a) No vehicle of any description, whether belonging to a resident or otherwise, may park anywhere on Phase 2 other than in one of the proper parking spaces provided for that purpose.
- (b) Each resident must not use the Phase 2 Car Parking Space of any other resident without his prior consent.
- (c) Each Phase 2 Car Parking Space may be used only for the parking of one private car or one motor cycle (as the case may be); the carrying out of repairs and the storage of anything whatsoever is strictly prohibited.
- (d) No lorries, commercial or goods vehicles may be parked in any Phase 2 Car Parking Space (other than light vans or taxis belonging to an Owner or occupier of the Residential Development), except that delivery vehicles and such like visiting Phase 2 on legitimate business may, as directed by the Manager, use spaces which are reserved for that purpose.
- (e) Any vehicle parked in contravention of the above rules, may be impounded or removed by the Manager without prior warning. The Manager may also, without liability to its owner, remove and dispose of any derelict vehicle which is an eyesore or otherwise causing nuisance to the residents, (notwithstanding that it has been left in a designated parking space). All cost and charges incurred or levied by the Manager shall be recoverable from the owner of the vehicle impounded or removed.
4. The following matters require the prior written consent of the Manager, which may be granted, withheld (such consent shall not be unreasonably withheld), or granted subject to conditions, and work must not commence unless and until such consent has been obtained :-
 - (a) the installation of air-conditioners and any similar or related plant or equipment (other than the usual domestic type air-conditioning units at the air-conditioning plinth(s) appertaining to

the relevant Phase 2 Residential Unit or at the air-conditioner platform or air-conditioning plinth in the Phase 2 Residential Common Areas designated for such purposes for the relevant Phase 2 Residential Unit), subject to the Manager's right to require such subsequent modifications (or complete removal) of any installed air-conditioners or similar or related plant or equipment (whether or not the installation of the same requires the Manager's consent under this Clause) as they may deem necessary including, without limitation, the taking of measures to avoid condensation dripping on the premises below;

- (b) the installation and/or use of window guard;

PROVIDED THAT the Manager must not charge any fee other than a reasonable administrative fee for issuing the consent and such fee must be credited to the relevant account(s) of the Special Fund for Phase 2.

5. No washing may be hung on or anything projected from or out of any roof, flat roof, garden, Phase 2 Balcony, Phase 2 Utility Platform or window of the Phase 2 Residential Units or any other buildings on Phase 2 PROVIDED THAT drying of clothes is allowed in any Phase 2 Utility Platform below the railing level.

6. Each resident is required to keep his Unit in a good state of preservation and cleanliness and is responsible for ensuring that no dirt, garbage, waste or other matter is dropped, swept or thrown outside onto the Common Areas, or the premises of any other resident.

7. Garbage and refuse from each Unit shall be removed and handled in such manner as the Manager may direct.

8. Residents must not play or operate any musical instrument, radio, television, recording equipment or such like, or cause or permit or suffer any noise to emanate from their Units so as to cause a nuisance to other Owners, residents or occupiers of the Estate.

9. The Phase 2 Residential Units are to be used for residential purposes only and must not be used for or in connection with any business or for gambling or any illegal or immoral purpose.

10. Notwithstanding Clause 1(x) in the Third Schedule of the Principal Deed, no Owner or resident shall bring or keep in any Unit any dogs, cats, pets, live poultry or other animals which may be the subject of reasonable complaint from at least two (2) Owners or occupiers of any part of the Estate, the reasonableness of such complaint shall be determined by the Manager at its absolute discretion PROVIDED THAT this provision shall not apply to guide dogs required for persons with disability in vision and PROVIDED FURTHER THAT:-

- (a) in no event shall dogs be permitted in lifts or in any part of the Estate intended for common use unless they are carried or on leash and wearing mouth strap;
- (b) notwithstanding anything contained in the foregoing, in no event shall dogs be permitted in the Common Areas (including without limitation the Club House(s) and lawn areas) save for those areas as may be designated by the Manager for use by dogs from time to time.

11. The Manager is empowered to make, revoke and amend the Fitting Out Rules relating to the carrying out of work to any Unit and rules and regulations governing the use and enjoyment of the swimming pool and all other recreational facilities.

12. Residents are not permitted to utilise any employee of the Manager or any of the staff of Phase 2 for their own private business or purposes.

13. Any consent or approval under Phase 2 House Rules given by the Manager may be revoked at any time PROVIDED THAT such consent or approval shall not be revoked unreasonably.

14. Any queries or complaints in regard to any matter concerning Phase 2 should be made to the Manager, preferably in writing.

THE FIFTH SCHEDULE
PHASE 2 WORKS AND INSTALLATIONS

1. structural elements;
2. external wall finishes and roofing materials;
3. fire safety elements;
4. plumbing system;
5. drainage system;
6. fire services installations and equipment;
7. electrical wiring system;
8. lift installations;
9. gas supply system;
10. window installations;
11. ventilation and air-conditioning systems;
12. curtain wall;
13. gondolas;
14. soft and hard landscape works;
15. telecommunication systems;
16. carpark control system;
17. security system; and
18. swimming pool and water features filtration systems.

THE SIXTH SCHEDULE

PHASE 2 BALCONIES AND PHASE 2 UTILITY PLATFORMS

PHASE 2 BALCONIES

<u>Tower</u>	<u>Unit which has a Phase 2 Balcony</u>
1 (1A)	6/F – 31/F : Units A, B, C, D and E 32/F : Units A and B
1 (1B)	6/F – 31/F : Units A, B, C, D, E and F 32/F : Units A, B and C
2 (2A)	6/F – 37/F : Units A, B, C, D, E and F 38/F : Units A, B and C
2 (2B)	6/F – 8/F, 10/F – 36/F : Unit A 6/F – 8/F, 10/F – 37/F : Units B, C, E, F and G 6/F – 8/F : Unit D 37/F and 38/F : Unit A (Duplex) 38/F : Units B and C

PHASE 2 UTILITY PLATFORMS

<u>Tower</u>	<u>Unit which has a Phase 2 Utility Platform</u>
1 (1A)	6/F – 31/F : Units A, B, C, D and E
1 (1B)	6/F – 31/F : Units A, B, C, D, E and F 32/F : Units B and C
2 (2A)	6/F – 37/F : Units A, B, C, D and F
2 (2B)	6/F – 8/F, 10/F – 36/F : Unit A 6/F – 8/F, 10/F – 37/F : Units B, C, E and G

Notes:

1. 9/F in Tower 1 (1A and 1B) is the refuge floor; 9/F in Tower 2 (2A and 2B) is the refuge floor.
2. There are no designations of 4/F, 13/F, 14/F and 24/F in Tower 1 (1A and 1B).
3. There are no designations of 4/F, 13/F, 14/F, 24/F and 34/F in Tower 2 (2A and 2B).

SIGNED SEALED and DELIVERED)
by)
)
the lawful attorney of MTR Corporation Limited)
(香港鐵路有限公司) in its capacity as registered)
owner of the Units in Phase 2 of the Estate (except)
the First Assigned Premises) whose signature is)
verified by :)







SIGNED SEALED and DELIVERED)
by the Purchaser in the presence of:)

SIGNED SEALED and DELIVERED)
by)
)
the lawful attorney of [] in its)
capacity as the Manager whose signature is)
verified by:)

N
1 : 400 IN A3

SITE B OF WONG CHUK HANG
STATION PROPERTY DEVELOPMENT

LEGENDS:

-  ESTATE COMMON AREAS IN PHASE 2 (PEDESTRIAN WALKWAY)
-  ESTATE COMMON AREAS IN PHASE 2 (PEDESTRIAN WALKWAY) (GREENERY AREA) (24.112m²)
-  PHASE 2 COMMON AREAS
-  PHASE 2 RESIDENTIAL COMMON AREAS
-  SITE B BOUNDARY
-  COMMON ACCESS

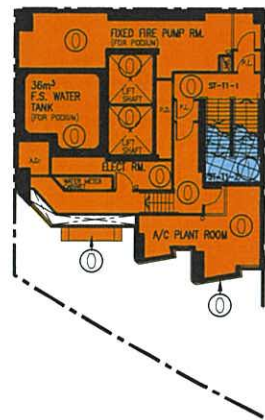

PART PLAN
AT LEV. 21.30

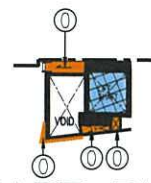

PART PLAN
AT LEV. 21.78

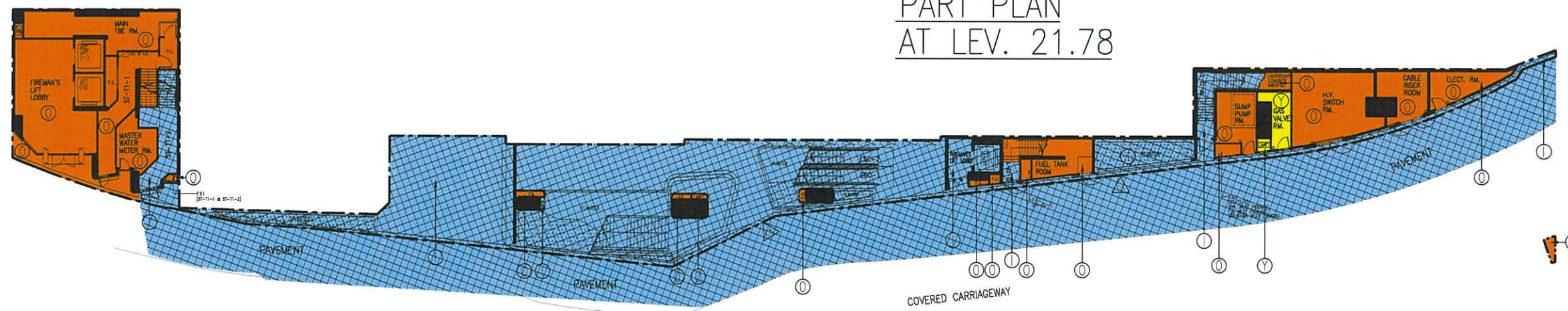

2ND FLOOR PLAN

I HEREBY CERTIFY THE ACCURACY OF THIS PLAN.

 LEE MING YEN JENNIFER
 AUTHORIZED PERSON - ARCHITECT
 DATE : 2021.06.30

N
1 : 400 IN A3

**SITE B OF WONG CHUK HANG
STATION PROPERTY DEVELOPMENT**

LEGENDS:

- ESTATE COMMON AREAS IN PHASE 2
- ESTATE COMMON AREAS IN PHASE 2 (PEDESTRIAN WALKWAY)
- RESIDENTIAL DEVELOPMENT COMMON AREAS IN PHASE 2
- PHASE 2 COMMON AREAS
- PHASE 2 RESIDENTIAL COMMON AREAS
- PHASE 2 CAR PARK COMMON AREAS
- SITE B BOUNDARY



3RD FLOOR PLAN

I HEREBY CERTIFY THE ACCURACY OF THIS PLAN.



LEE MING YEN JENNIFER
AUTHORIZED PERSON - ARCHITECT

DATE : 2021.06.30

**SITE B OF WONG CHUK HANG
STATION PROPERTY DEVELOPMENT**

LEGENDS:

- RESIDENTIAL DEVELOPMENT COMMON AREAS IN PHASE 2
- RESIDENTIAL DEVELOPMENT COMMON AREAS IN PHASE 2 (GREENERY AREA) (600.000m²)
- PHASE 2 COMMON AREAS
- PHASE 2 RESIDENTIAL COMMON AREAS
- PHASE 2 RESIDENTIAL COMMON AREAS (GREENERY AREA) (1690.247m²)
- PHASE 2 CAR PARK COMMON AREAS
- SITE B BOUNDARY
- COMMON ACCESS

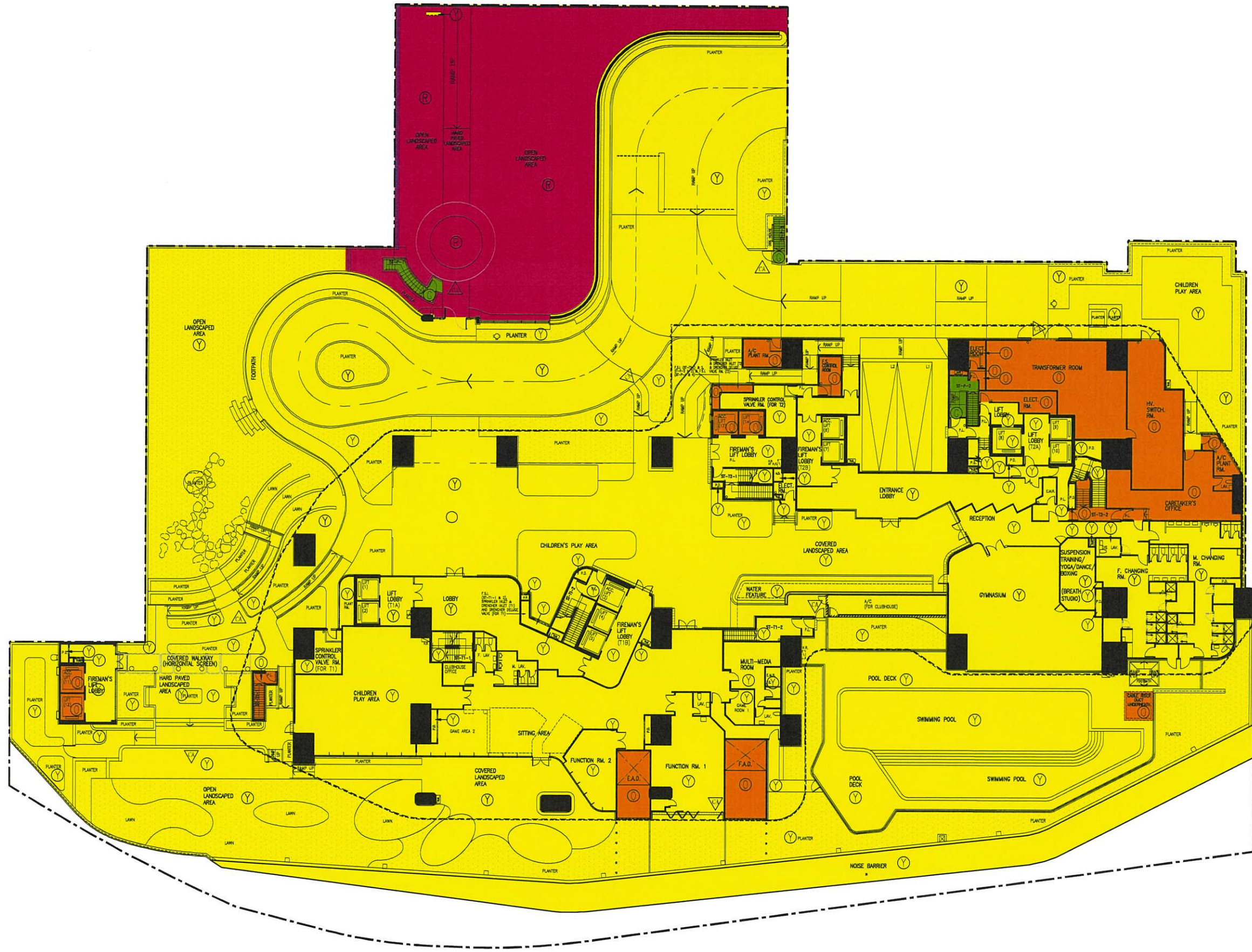

PODIUM FLOOR PLAN

I HEREBY CERTIFY THE ACCURACY OF THIS PLAN.

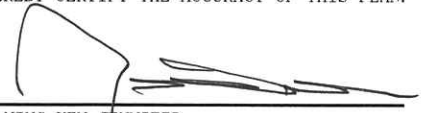
 LEE MING YEN JENNIFER
 AUTHORIZED PERSON - ARCHITECT
 DATE : 2021.06.30

N
1 : 400 IN A3

SITE B OF WONG CHUK HANG
STATION PROPERTY DEVELOPMENT

LEGENDS:

- PHASE 2 RESIDENTIAL COMMON AREAS
- PHASE 2 RESIDENTIAL COMMON AREAS
(WIDER COMMON CORRIDORS AND LIFT LOBBIES)
- PHASE 2 RESIDENTIAL COMMON AREAS
(GREENERY AREA)
(607.866m²)
- NON-STRUCTURAL PREFABRICATED EXTERNAL WALLS
- SITE B BOUNDARY
- COMMON ACCESS



5TH FLOOR PLAN (TOWER 1 AND TOWER 2)

I HEREBY CERTIFY THE ACCURACY OF THIS PLAN.



 LEE MING YEN JENNIFER
 AUTHORIZED PERSON - ARCHITECT
 DATE : 2021.06.30

N
1 : 200 IN A3

**SITE B OF WONG CHUK HANG
STATION PROPERTY DEVELOPMENT**

LEGENDS:

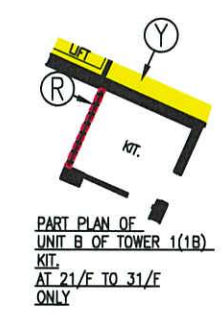
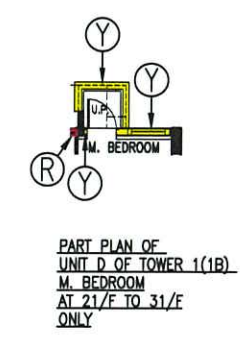
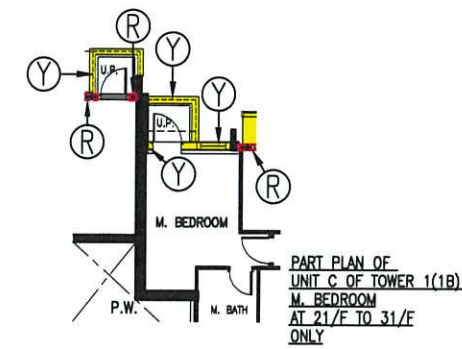
- PHASE 2 RESIDENTIAL COMMON AREAS
- PHASE 2 RESIDENTIAL COMMON AREAS
(WIDER COMMON CORRIDORS AND LIFT LOBBIES)
- NON-STRUCTURAL PREFABRICATED EXTERNAL WALLS



6TH TO 8TH & 10TH TO 31ST FLOOR PLAN (TOWER 1)
(OMITTED 13/F, 14/F & 24/F)

I HEREBY CERTIFY THE ACCURACY OF THIS PLAN.

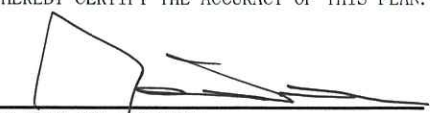
LEE MING YEN JENNIFER
AUTHORIZED PERSON - ARCHITECT
DATE : 2021.06.30

LEGENDS:

Y PHASE 2 RESIDENTIAL COMMON AREAS



9TH FLOOR PLAN (TOWER 1)

I HEREBY CERTIFY THE ACCURACY OF THIS PLAN.

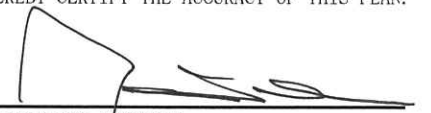
 LEE MING YEN JENNIFER
 AUTHORIZED PERSON - ARCHITECT
 DATE : 2021.06.30

SITE B OF WONG CHUK HANG
STATION PROPERTY DEVELOPMENT

LEGENDS:

- PHASE 2 RESIDENTIAL COMMON AREAS
- PHASE 2 RESIDENTIAL COMMON AREAS
(WIDER COMMON CORRIDORS AND LIFT LOBBIES)
- NON-STRUCTURAL PREFABRICATED EXTERNAL WALLS



32ND FLOOR PLAN (TOWER 1)

I HEREBY CERTIFY THE ACCURACY OF THIS PLAN.

 LEE MING YEN JENNIFER
 AUTHORIZED PERSON - ARCHITECT
 DATE : 2021.06.30

N
1 : 200 IN A3

SITE B OF WONG CHUK HANG
STATION PROPERTY DEVELOPMENT
LEGENDS:

Y PHASE 2 RESIDENTIAL COMMON AREAS



ROOF PLAN (TOWER 1)

I HEREBY CERTIFY THE ACCURACY OF THIS PLAN.

LEE MING YEN JENNIFER
AUTHORIZED PERSON - ARCHITECT

DATE : 2021.06.30

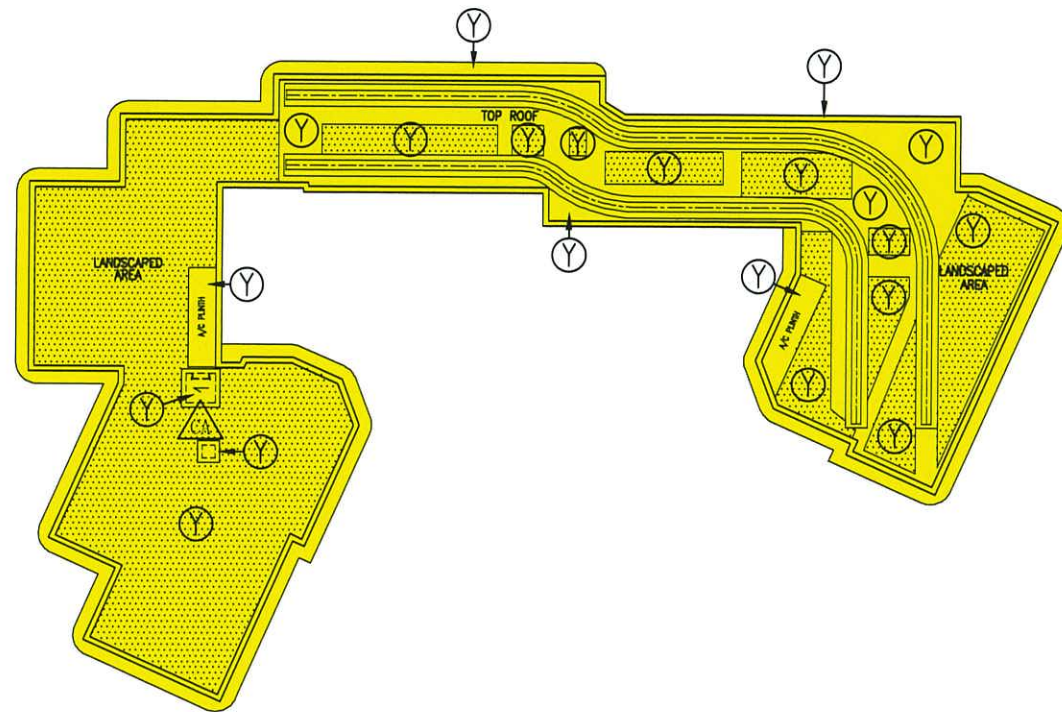

TOP ROOF PLAN (TOWER 1)

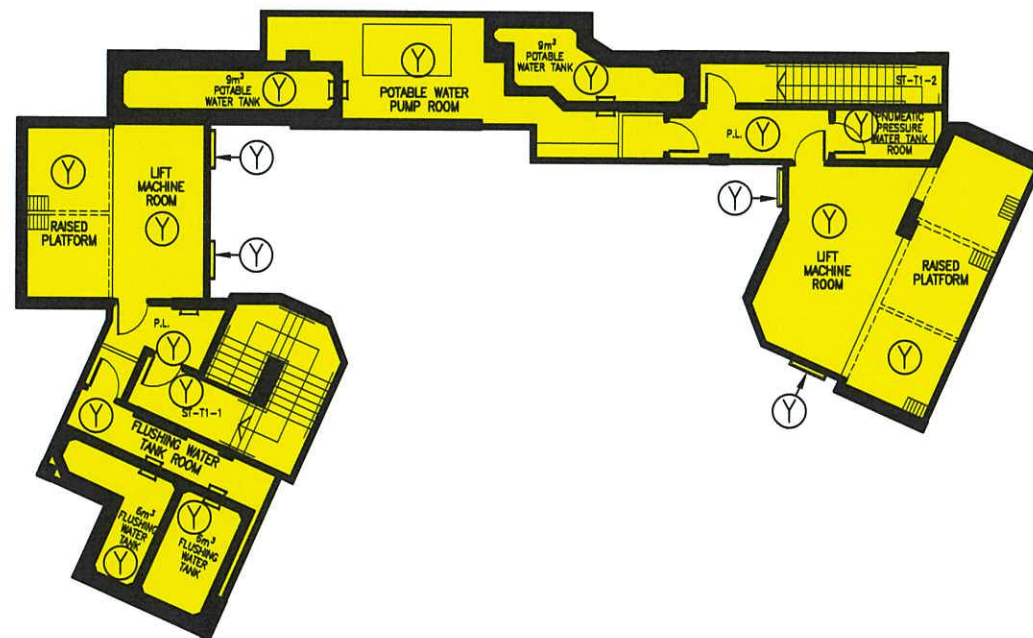

UPPER ROOF PLAN (TOWER 1)

N
1 : 200 IN A3

SITE B OF WONG CHUK HANG
STATION PROPERTY DEVELOPMENT
LEGENDS:

- PHASE 2 RESIDENTIAL COMMON AREAS
- PHASE 2 RESIDENTIAL COMMON AREAS (GREENERY AREA) (110.494m²)
- COMMON ACCESS

I HEREBY CERTIFY THE ACCURACY OF THIS PLAN.

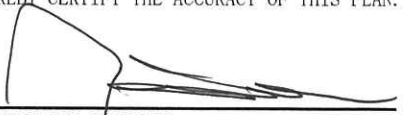
 LEE MING YEN JENNIFER
 AUTHORIZED PERSON - ARCHITECT
 DATE : 2021.06.30

N
1 : 200 IN A3

SITE B OF WONG CHUK HANG
STATION PROPERTY DEVELOPMENT

LEGENDS:

- PHASE 2 RESIDENTIAL COMMON AREAS
- PHASE 2 RESIDENTIAL COMMON AREAS
(WIDER COMMON CORRIDORS AND LIFT LOBBIES)
- NON-STRUCTURAL PREFABRICATED EXTERNAL WALLS



6TH TO 8TH FLOOR PLAN (TOWER 2)

I HEREBY CERTIFY THE ACCURACY OF THIS PLAN.

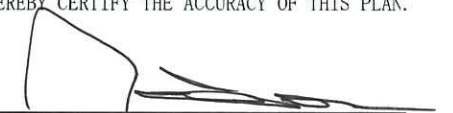
LEE MING YEN JENNIFER
AUTHORIZED PERSON - ARCHITECT
DATE : 2021.06.30

N
1 : 200 IN A3

SITE B OF WONG CHUK HANG
STATION PROPERTY DEVELOPMENT
LEGENDS :

Y PHASE 2 RESIDENTIAL COMMON AREAS



9TH FLOOR PLAN (TOWER 2)

I HEREBY CERTIFY THE ACCURACY OF THIS PLAN.

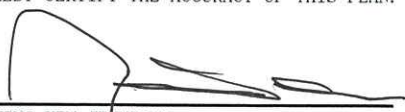
LEE MING YEN JENNIFER
AUTHORIZED PERSON - ARCHITECT
DATE : 2021.06.30

SITE B OF WONG CHUK HANG
STATION PROPERTY DEVELOPMENT

LEGENDS:

- PHASE 2 RESIDENTIAL COMMON AREAS
- PHASE 2 RESIDENTIAL COMMON AREAS
(WIDER COMMON CORRIDORS AND LIFT LOBBIES)
- NON-STRUCTURAL PREFABRICATED EXTERNAL WALLS



10TH TO 36TH FLOOR PLAN (TOWER 2)
(OMITTED 13/F, 14/F, 24/F & 34/F)

I HEREBY CERTIFY THE ACCURACY OF THIS PLAN.

LEE MING YEN JENNIFER
AUTHORIZED PERSON - ARCHITECT
DATE : 2021.06.30

N
1 : 200 IN A3

SITE B OF WONG CHUK HANG
STATION PROPERTY DEVELOPMENT

LEGENDS:

- PHASE 2 RESIDENTIAL COMMON AREAS
- PHASE 2 RESIDENTIAL COMMON AREAS
(WIDER COMMON CORRIDORS AND LIFT LOBBIES)
- NON-STRUCTURAL PREFABRICATED EXTERNAL WALLS



37TH FLOOR PLAN (TOWER 2)

I HEREBY CERTIFY THE ACCURACY OF THIS PLAN.

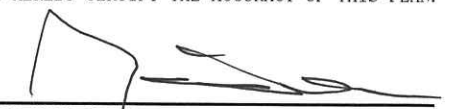
 LEE MING YEN JENNIFER
 AUTHORIZED PERSON - ARCHITECT
 DATE : 2021.06.30

N
1 : 200 IN A3

SITE B OF WONG CHUK HANG
STATION PROPERTY DEVELOPMENT

LEGENDS:

- PHASE 2 RESIDENTIAL COMMON AREAS
- PHASE 2 RESIDENTIAL COMMON AREAS
(WIDER COMMON CORRIDORS AND LIFT LOBBIES)
- NON-STRUCTURAL PREFABRICATED EXTERNAL WALLS



38TH FLOOR PLAN (TOWER 2)

I HEREBY CERTIFY THE ACCURACY OF THIS PLAN.

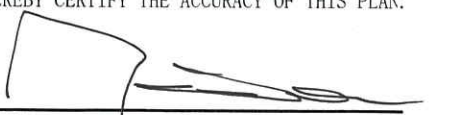
 LEE MING YEN JENNIFER
 AUTHORIZED PERSON - ARCHITECT
 DATE : 2021.06.30

N
1 : 200 IN A3

SITE B OF WONG CHUK HANG
STATION PROPERTY DEVELOPMENT
LEGENDS:

Y PHASE 2 RESIDENTIAL COMMON AREAS

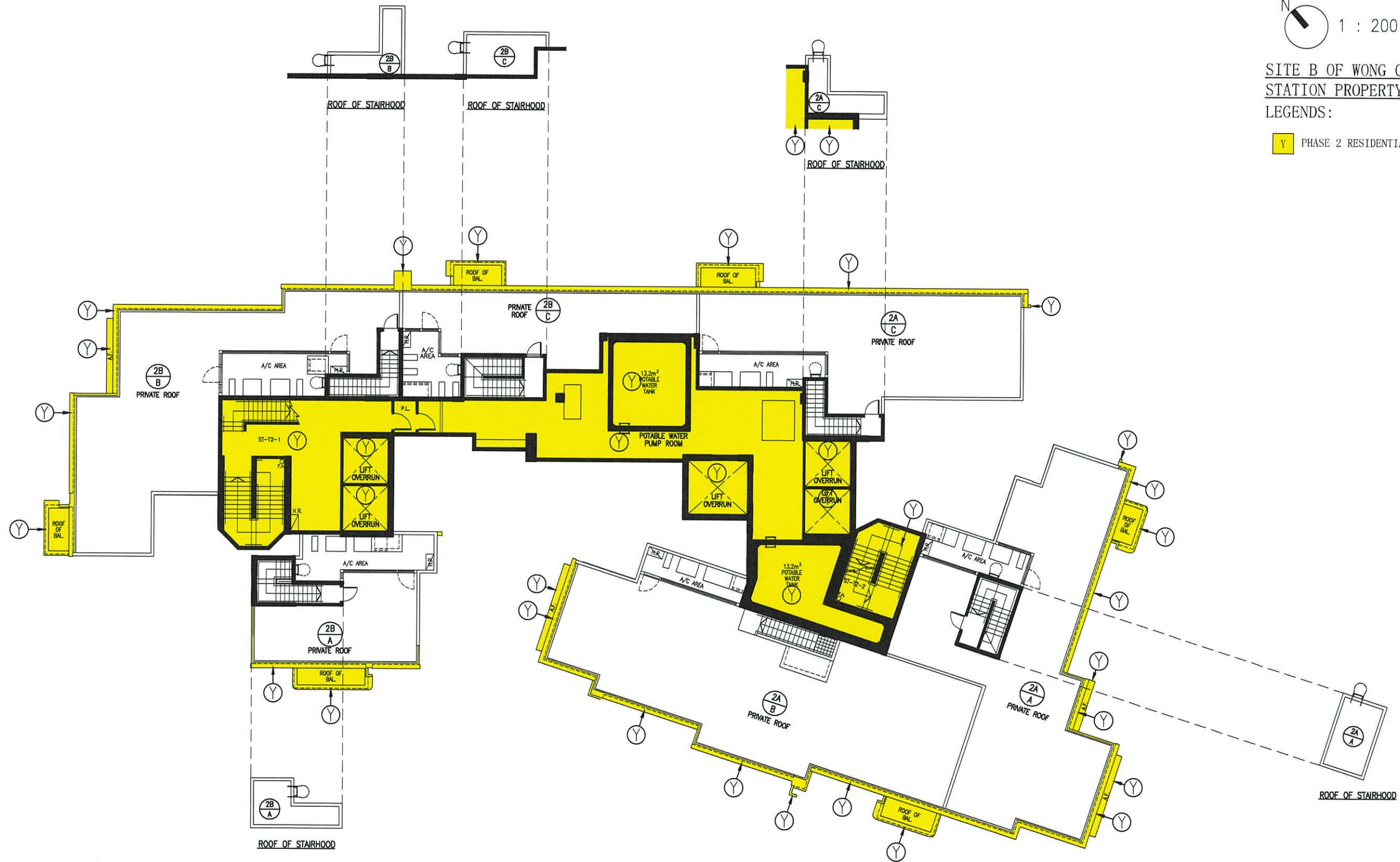

ROOF PLAN (TOWER 2)

I HEREBY CERTIFY THE ACCURACY OF THIS PLAN.

LEE MING YEN JENNIFER
AUTHORIZED PERSON - ARCHITECT
DATE : 2021.06.30

N
1 : 200 IN A3

SITE B OF WONG CHUK HANG
STATION PROPERTY DEVELOPMENT
LEGENDS:

- Y PHASE 2 RESIDENTIAL COMMON AREAS
- Y PHASE 2 RESIDENTIAL COMMON AREAS (GREENERY AREA) (139.296m²)
- CA COMMON ACCESS

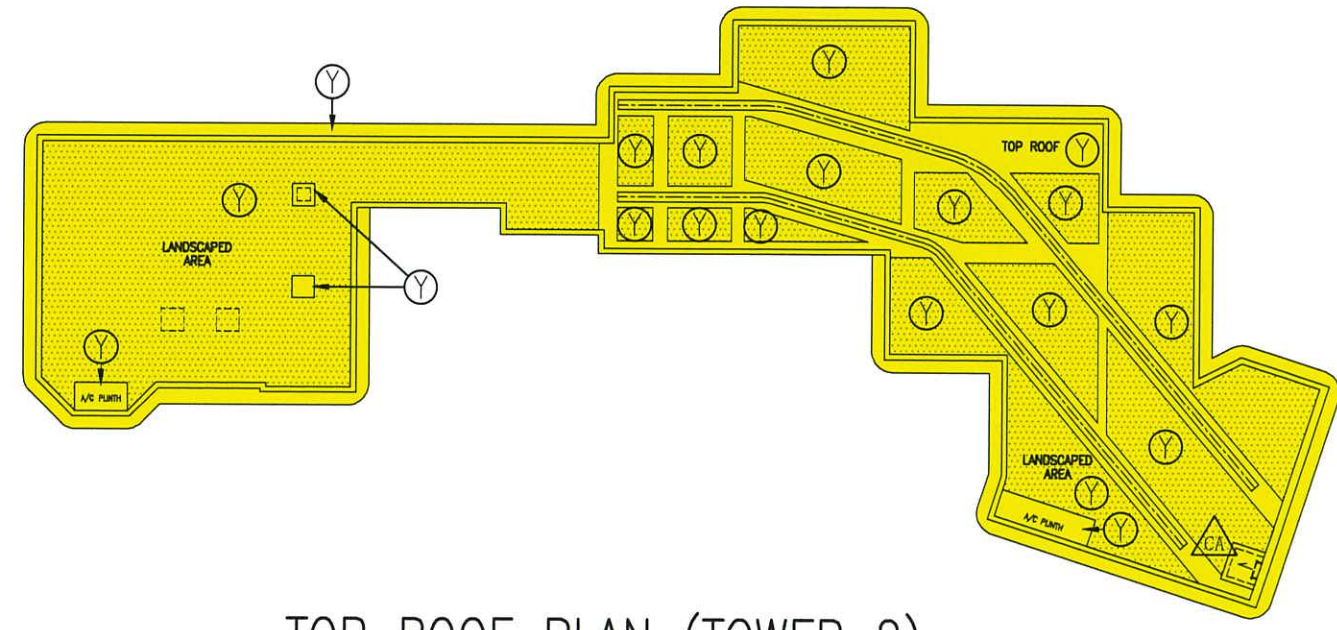

TOP ROOF PLAN (TOWER 2)

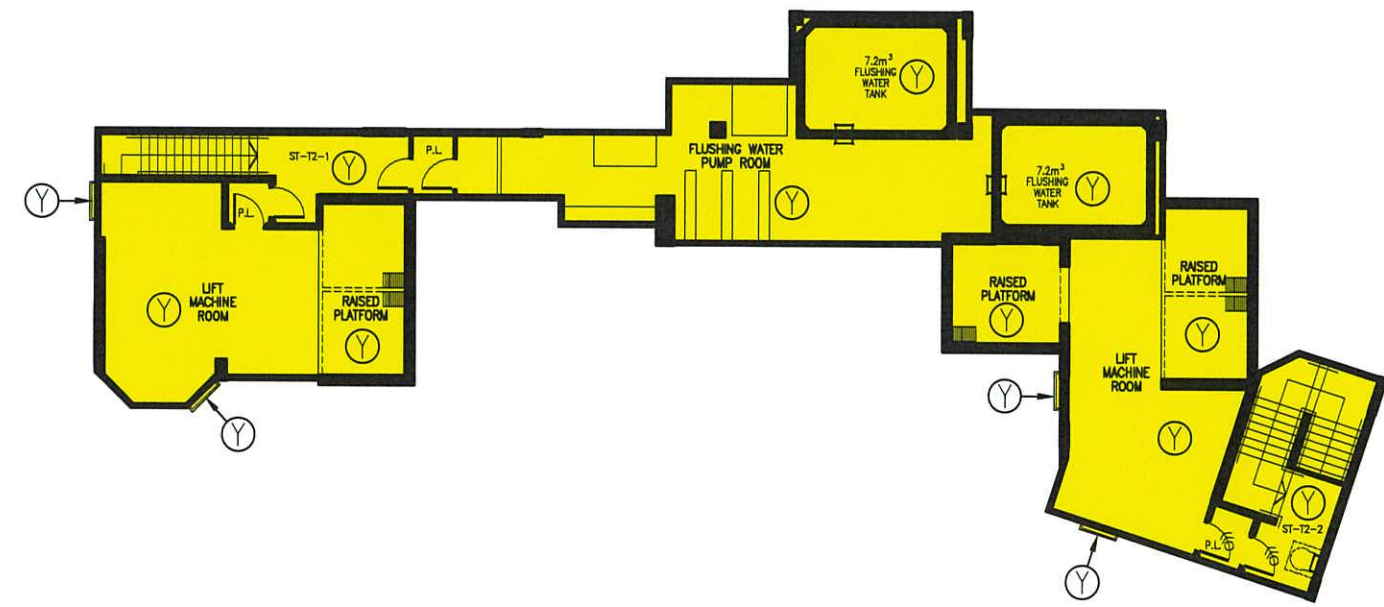

UPPER ROOF PLAN (TOWER 2)

I HEREBY CERTIFY THE ACCURACY OF THIS PLAN.

 LEE MING YEN JENNIFER
 AUTHORIZED PERSON - ARCHITECT
 DATE : 2021.06.30